

STUDIO

ARGYLE

381 SQ.FT. F1-1 • 40 SQ.FT. TERRACE
391 SQ.FT. F1-2 • 42 SQ.FT. TERRACE

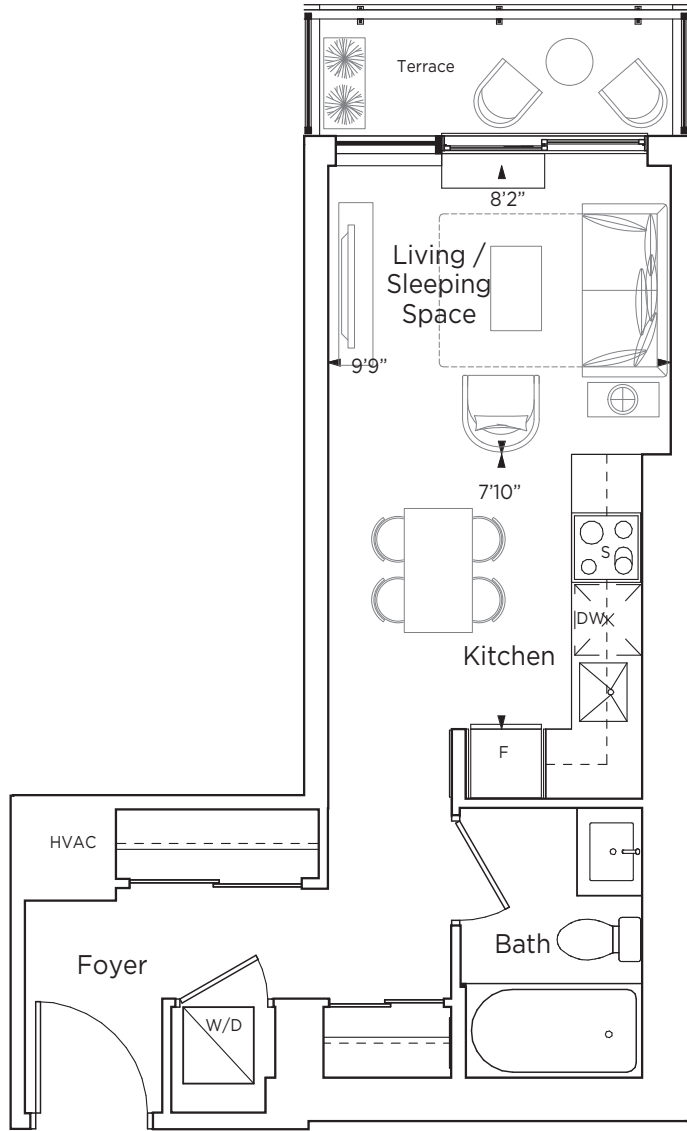

F1-1

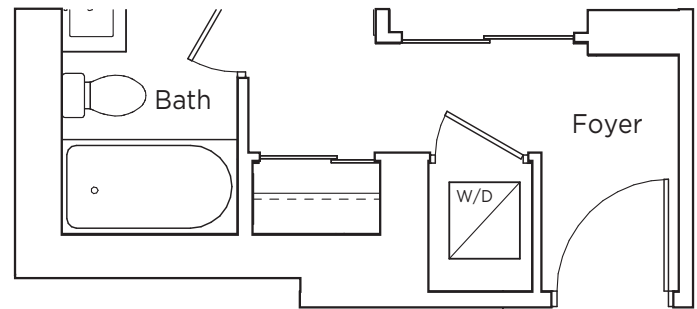

F1-2

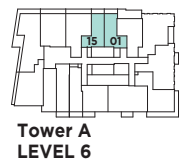

Materials, specifications and floor plans are subject to change. All renderings are artist's concept. All floor plans are approximate dimensions. Actual usable floor space may vary from stated floor area. Balcony/terrace areas may vary. Windows, room/area dimensions & square feet may vary due to location within building. Furniture not included. E. & O. E.

STUDIO

ASTON

388 SQ.FT. B4, B4-1 TO B4-5 • 401 SQ.FT. B4-6 • 377 SQ.FT. B4-7

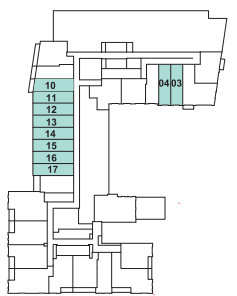
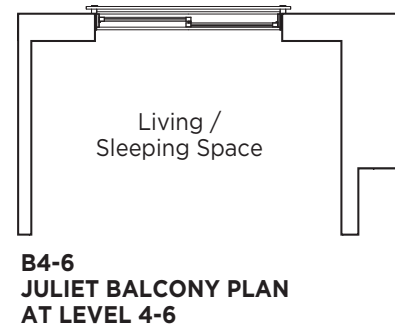
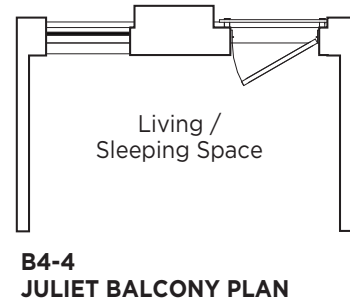
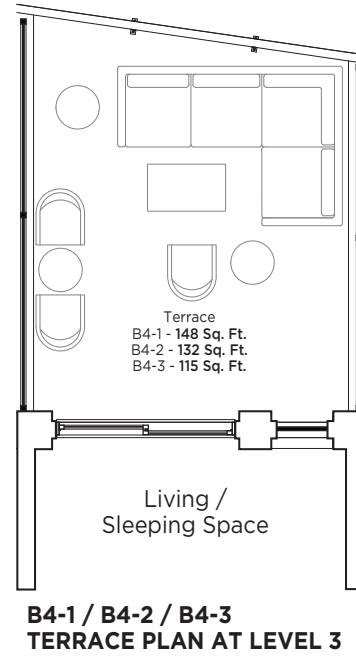
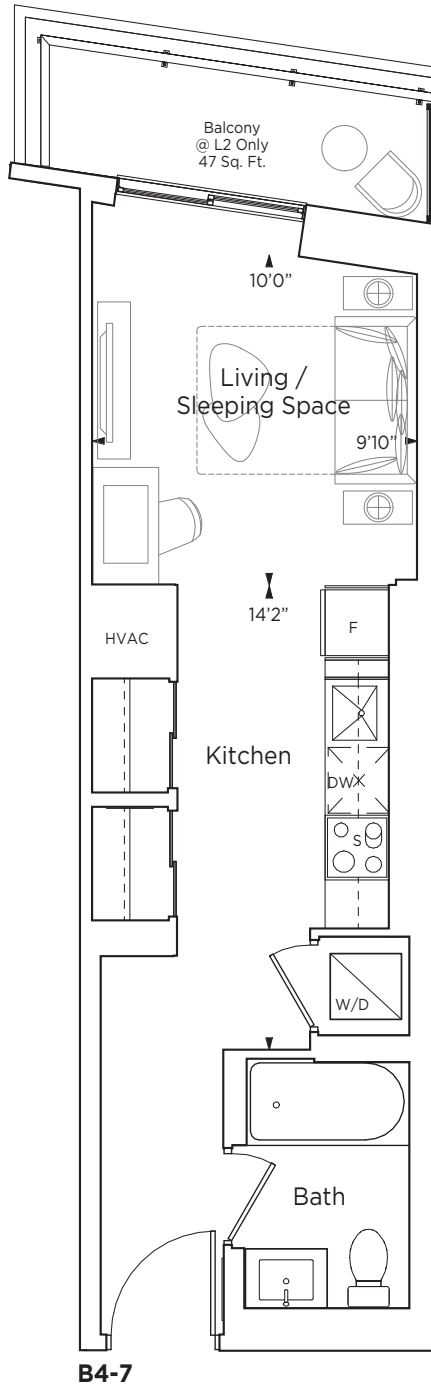
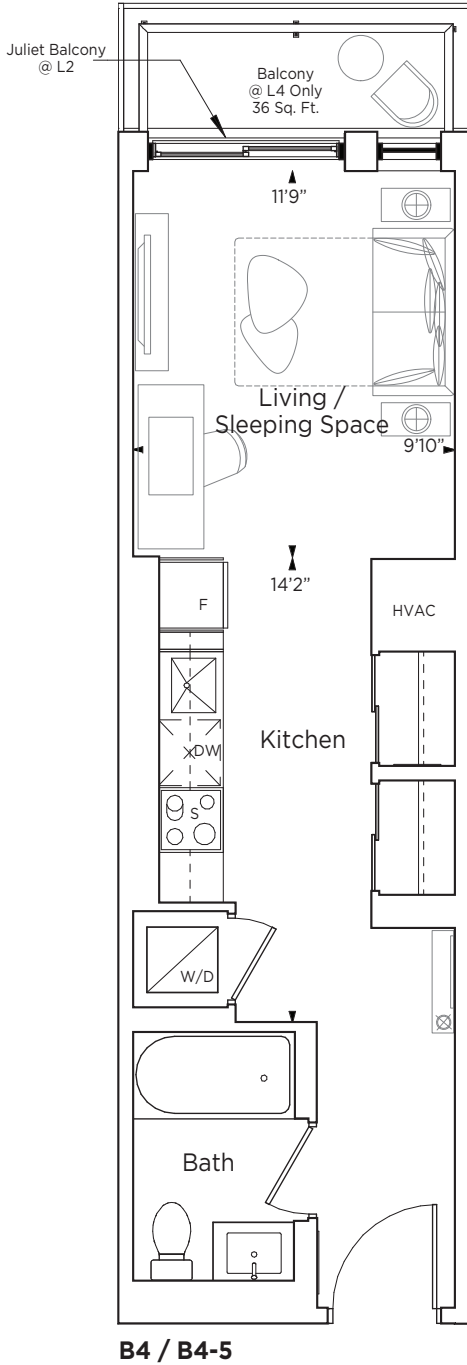

Vincent
CONDOMINIUMS



Materials, specifications and floor plans are subject to change. All renderings are artist's concept. All floor plans are approximate dimensions. Actual usable floor space may vary from stated floor area. Balcony/terrace areas may vary. Windows, room/area dimensions & square feet may vary due to location within building. Furniture not included. E. & O. E.

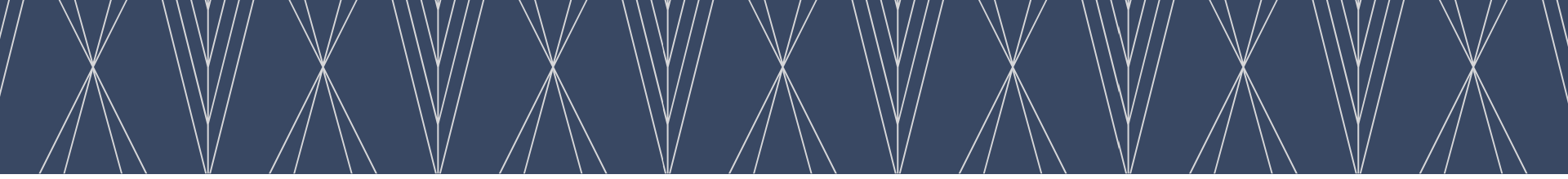

STUDIO
BACCARAT
 390 SQ.FT.

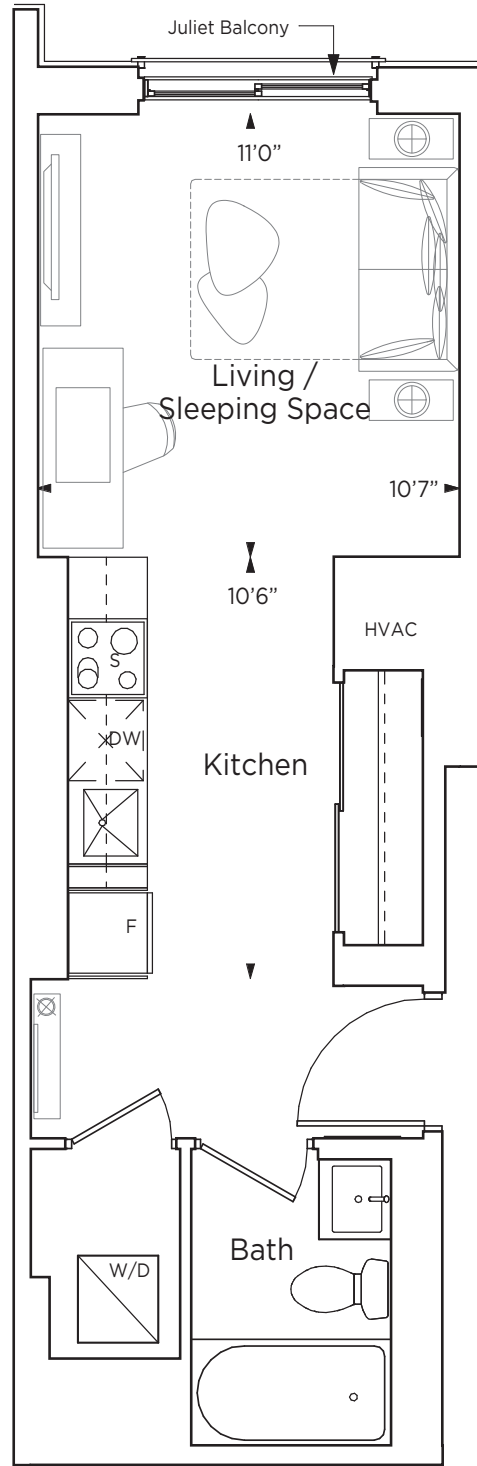

B3

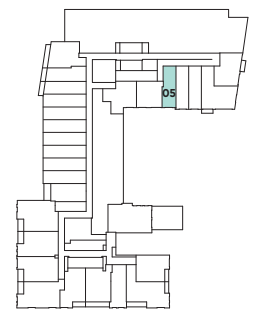

**Tower A
 LEVEL 2**



Materials, specifications and floor plans are subject to change. All renderings are artist's concept. All floor plans are approximate dimensions. Actual usable floor space may vary from stated floor area. Balcony/terrace areas may vary. Windows, room/area dimensions & square feet may vary due to location within building. Furniture not included. E. & O. E.

STUDIO

BAJA

396 SQ.FT. • 49 SQ.FT. BALCONY

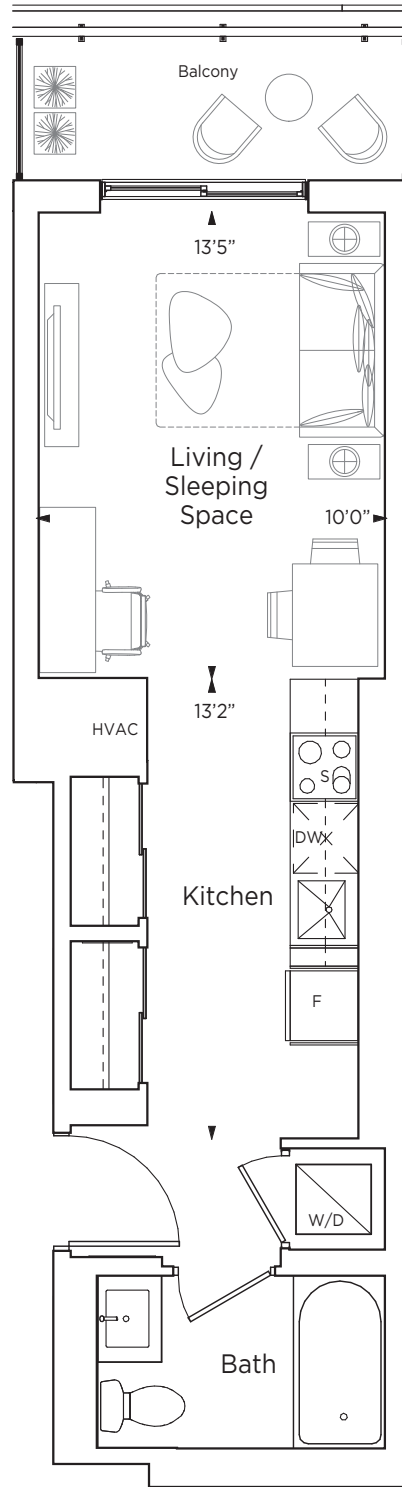

D9



Tower A
LEVEL 6



Tower A
LEVEL 5



Tower A
LEVEL 4



Vincent
CONDOMINIUMS



STUDIO

BANGKOK

400 SQ.FT. • 45 SQ.FT. BALCONY

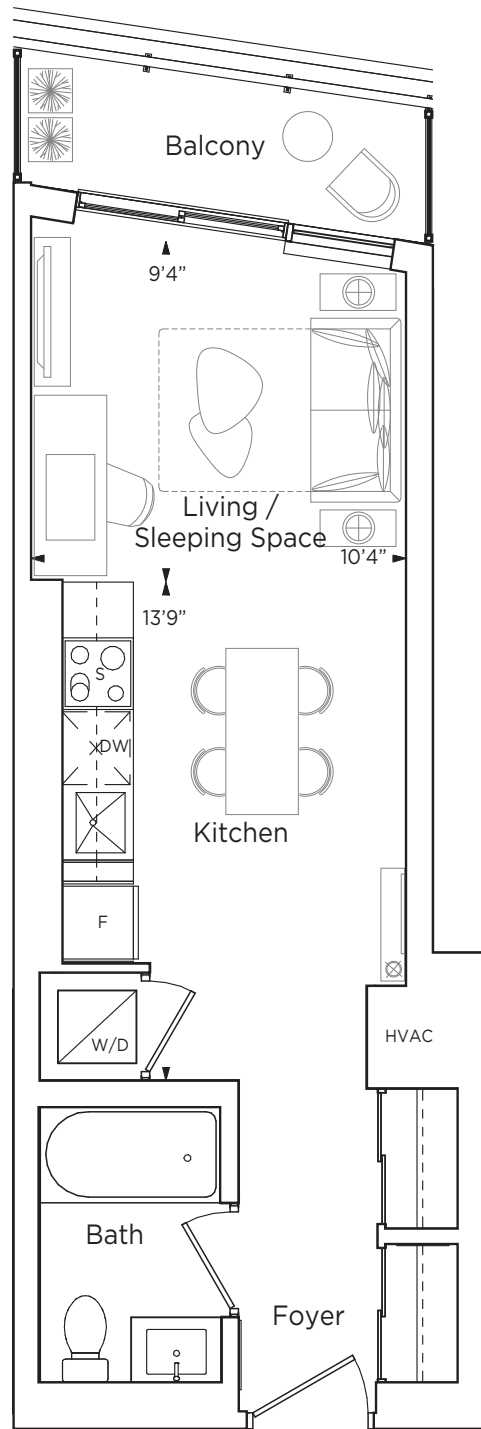

B2

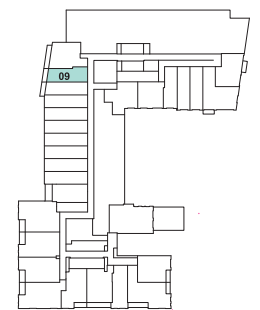

Tower A
LEVEL 2



Vincent
CONDOMINIUMS



Materials, specifications and floor plans are subject to change. All renderings are artist's concept. All floor plans are approximate dimensions. Actual usable floor space may vary from stated floor area. Balcony/terrace areas may vary. Windows, room/area dimensions & square feet may vary due to location within building. Furniture not included. E. & O. E.

ONE BED

BARCHETTA

432 SQ.FT. • 129 SQ.FT. TERRACE

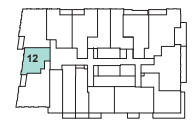
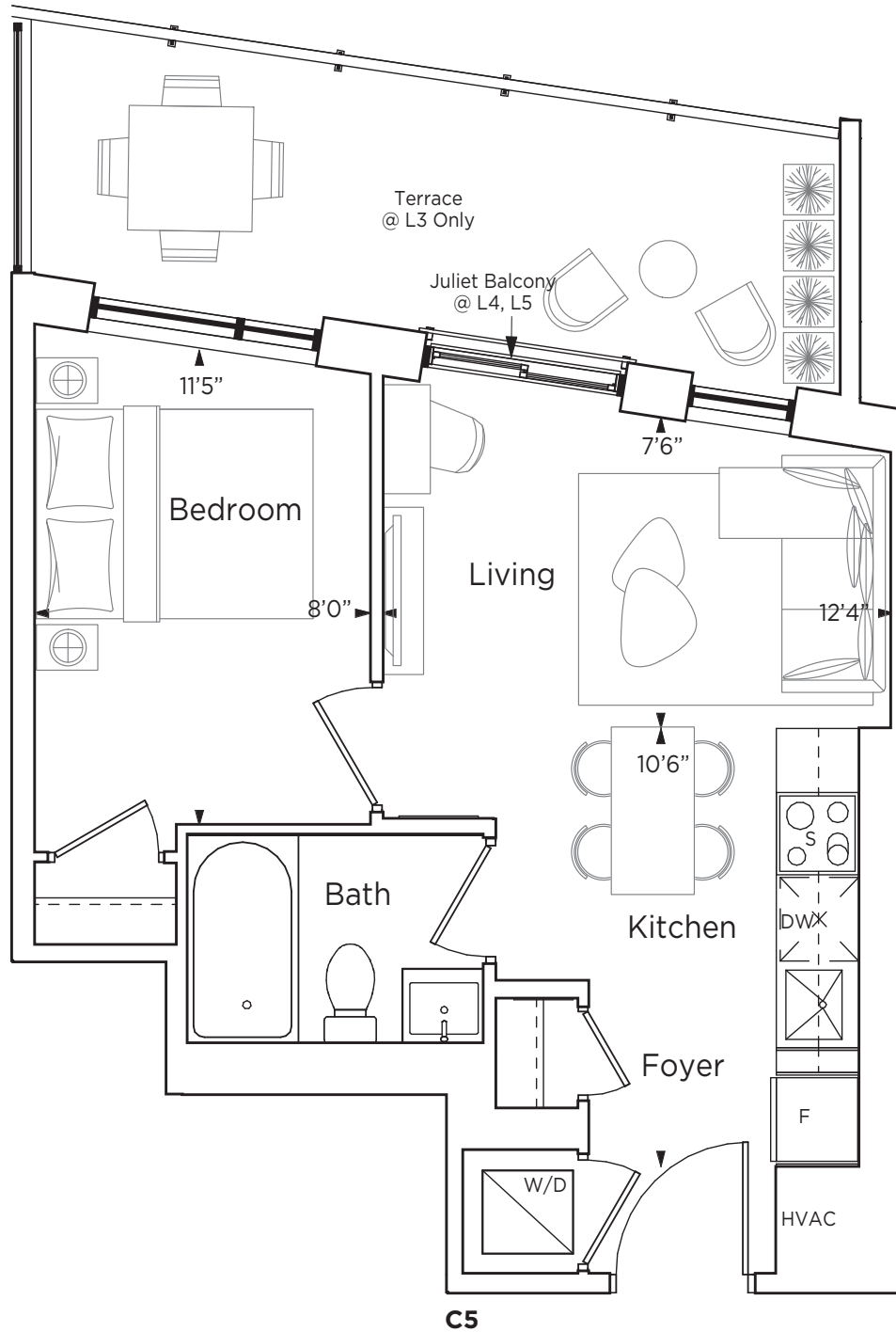

Tower A
LEVEL 5



Tower A
LEVEL 4



Tower A
LEVEL 3



Vincent
CONDOMINIUMS



STUDIO (BARRIER-FREE)

BELGRADE

433 SQ.FT. C1-1 • 443 SQ.FT. C1-2

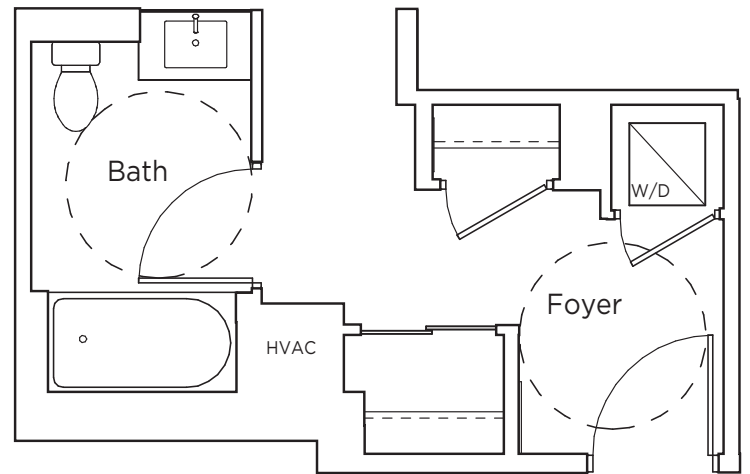
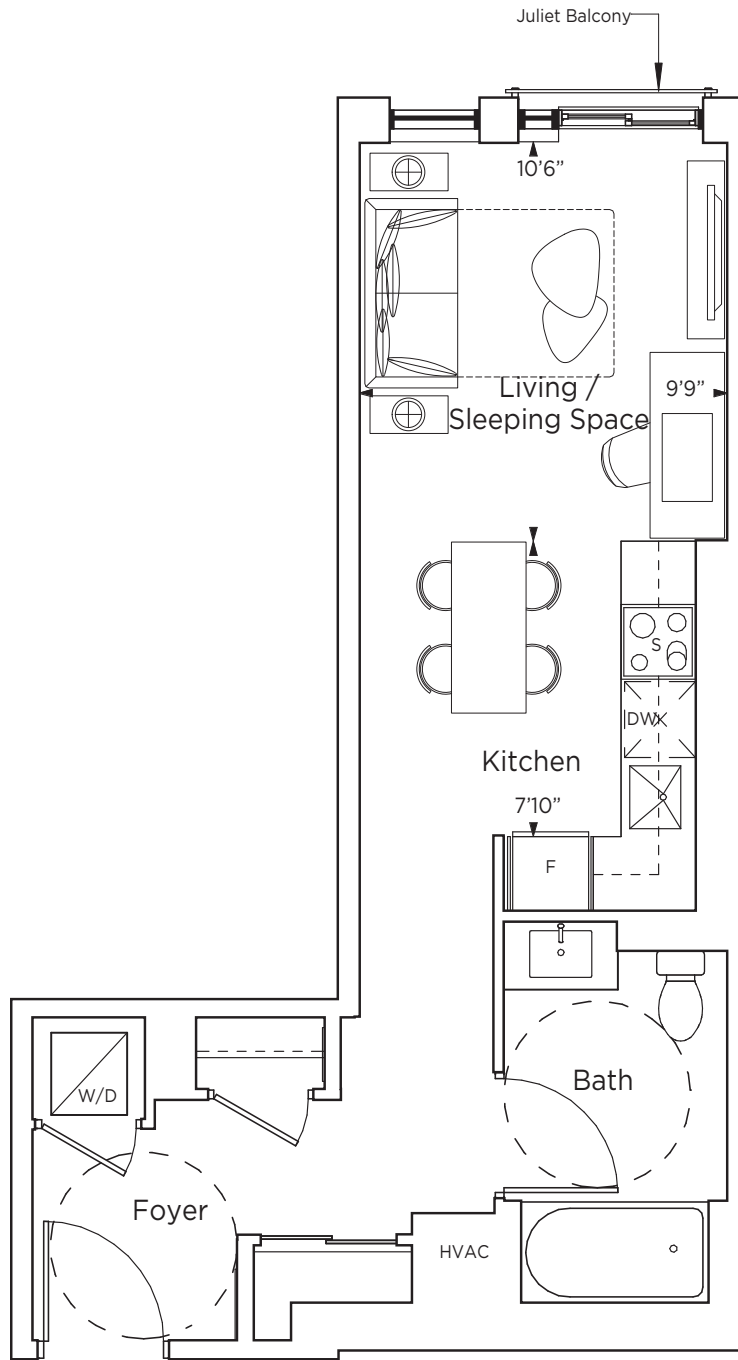

C1-1

C1-2

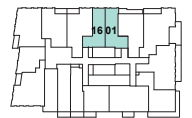

Tower A
LEVEL 5



Tower A
LEVEL 4

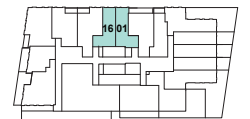

Tower A
LEVEL 3



Vincent
CONDOMINIUMS



STUDIO

BERLIN

440 SQ.FT. • 39 SQ.FT. BALCONY

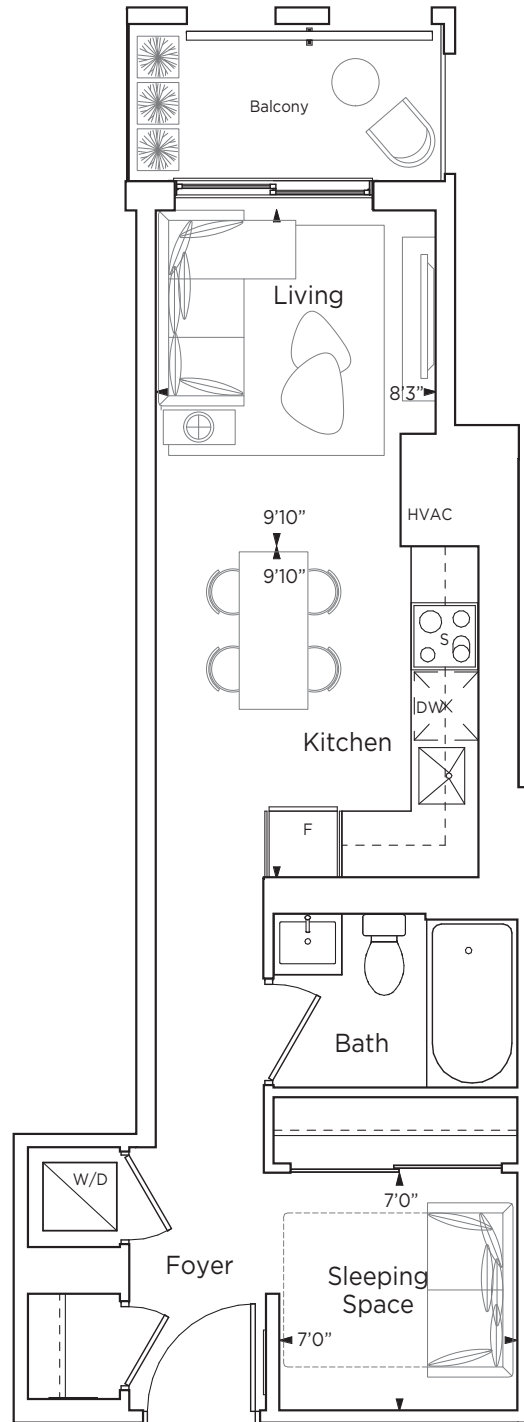

C14



Tower A
LEVEL 4



Tower A
LEVEL 3



Vincent
CONDOMINIUMS



Materials, specifications and floor plans are subject to change. All renderings are artist's concept. All floor plans are approximate dimensions. Actual usable floor space may vary from stated floor area. Balcony/terrace areas may vary. Windows, room/area dimensions & square feet may vary due to location within building. Furniture not included. E. & O. E.

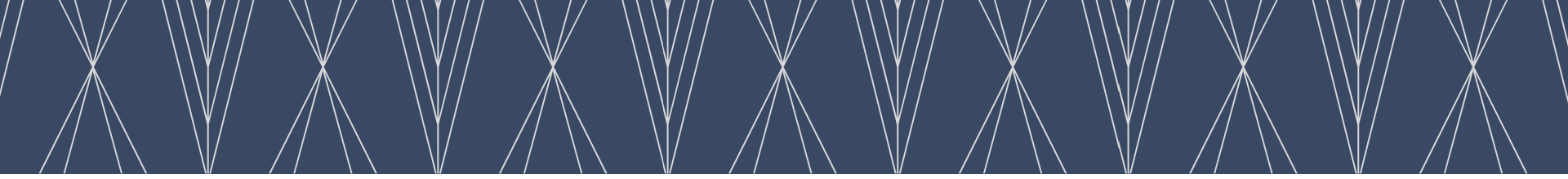

STUDIO

BLACK TIE

441 SQ.FT. • 48 SQ.FT. BALCONY

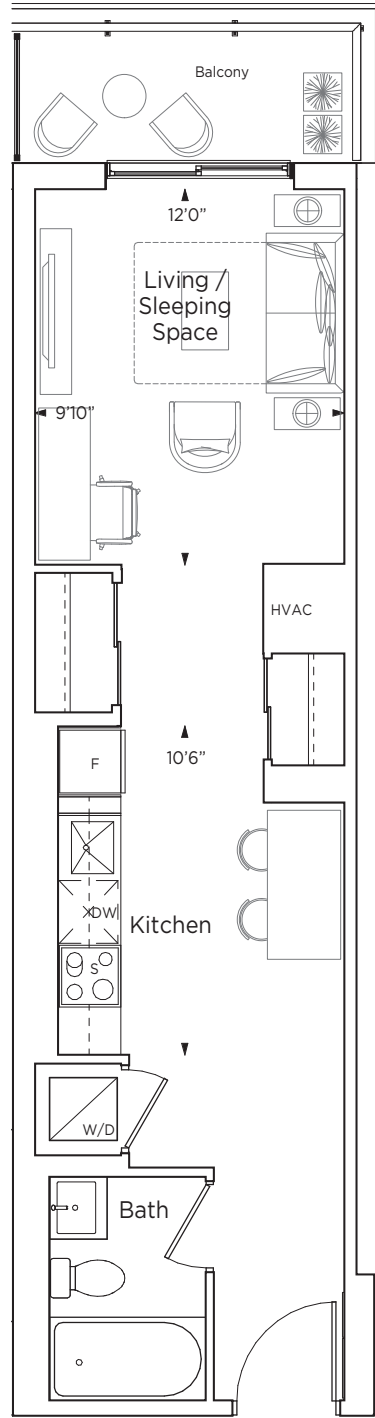

D8



Tower A
LEVEL 6



Tower A
LEVEL 5



Tower A
LEVEL 4



Vincent
CONDOMINIUMS



Materials, specifications and floor plans are subject to change. All renderings are artist's concept. All floor plans are approximate dimensions. Actual usable floor space may vary from stated floor area. Balcony/terrace areas may vary. Windows, room/area dimensions & square feet may vary due to location within building. Furniture not included. E. & O. E.

ONE BED

CARTE BLANCHE

479 SQ.FT. • 43 SQ.FT. BALCONY

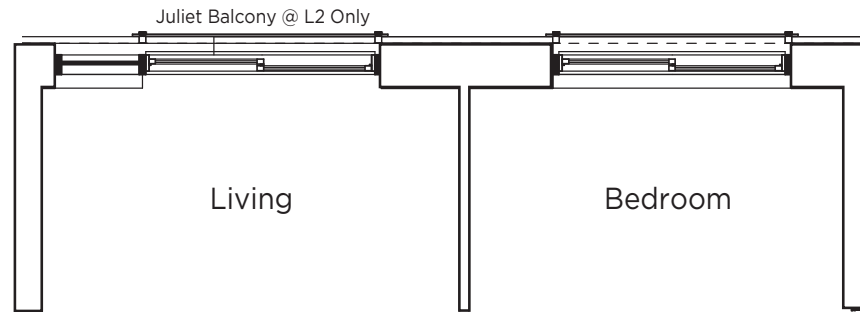

PLAN AT LEVEL 2 - 472 Sq. Ft.

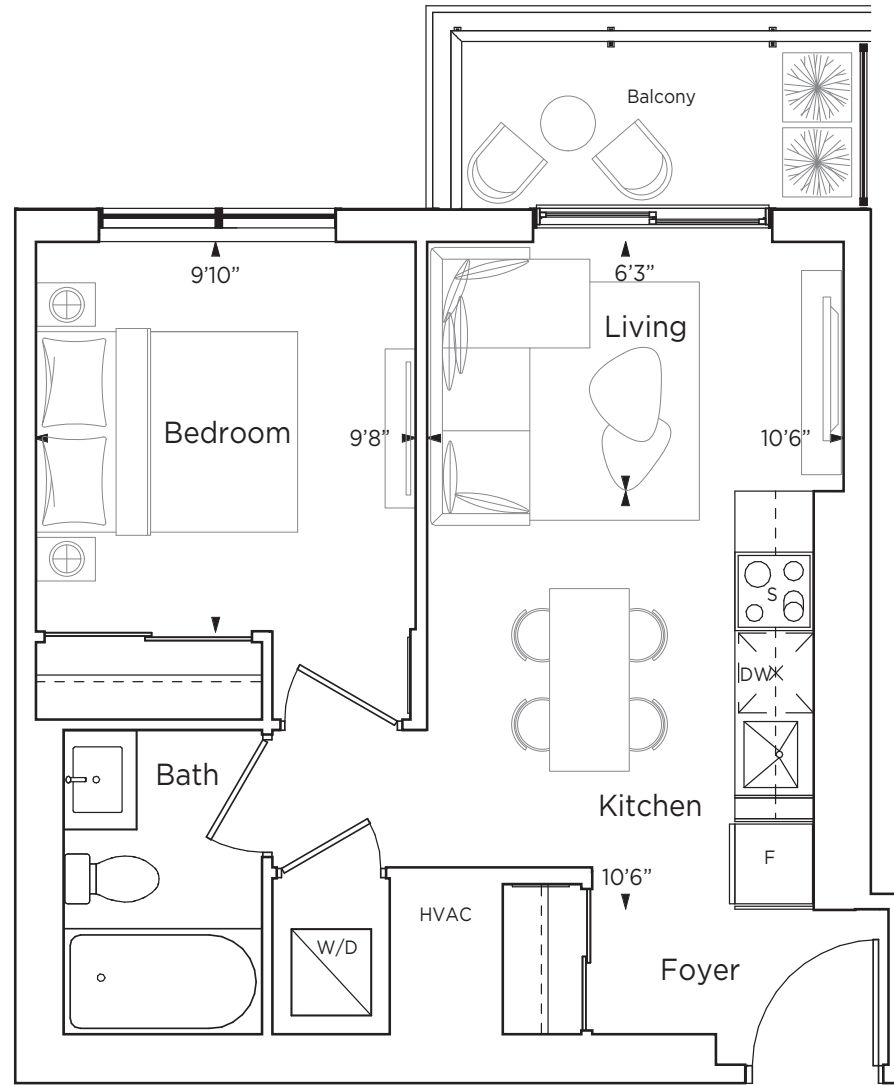

G6

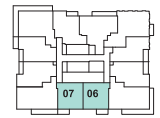

**Tower A
LEVEL 15-34**



**Tower A
LEVEL 7 - 14**



**Tower A
LEVEL 6**



**Tower A
LEVEL 5**



**Tower A
LEVEL 4**

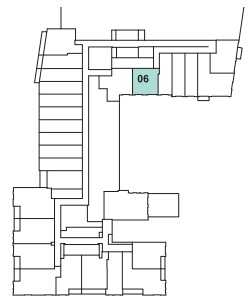

**Tower A
LEVEL 2**



Vincent
CONDOMINIUMS



Materials, specifications and floor plans are subject to change. All renderings are artist's concept. All floor plans are approximate dimensions. Actual usable floor space may vary from stated floor area. Balcony/terrace areas may vary. Windows, room/area dimensions & square feet may vary due to location within building. Furniture not included. E. & O. E.

ONE BED

CAVIAR

514 SQ.FT. • 152 SQ.FT. TERRACE

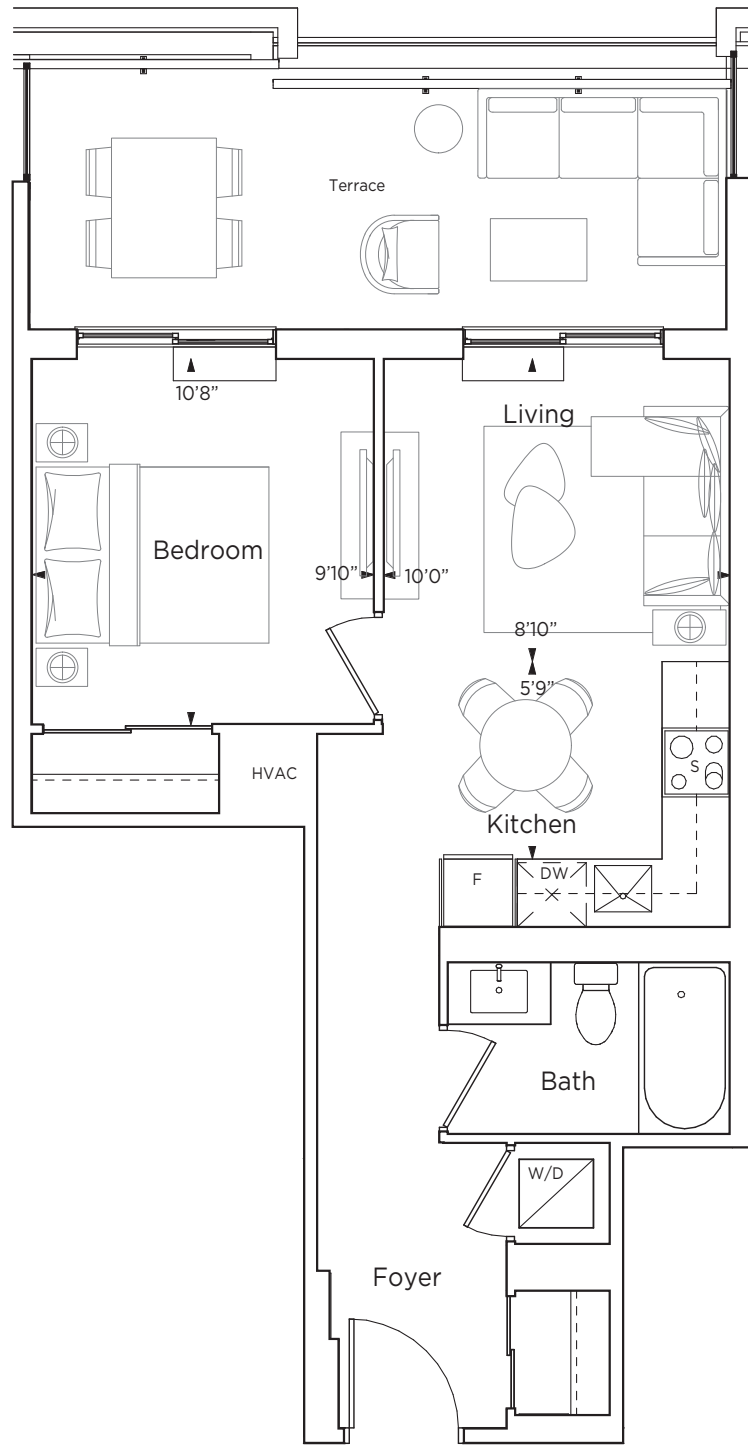

F14



Vincent
CONDOMINIUMS



Tower A
LEVEL 6

Materials, specifications and floor plans are subject to change. All renderings are artist's concept. All floor plans are approximate dimensions. Actual usable floor space may vary from stated floor area. Balcony/terrace areas may vary. Windows, room/area dimensions & square feet may vary due to location within building. Furniture not included. E. & O. E.

ONE BED (BARRIER-FREE)

CHAMPAGNE

518 SQ.FT. • 45 SQ.FT. BALCONY

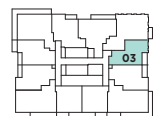
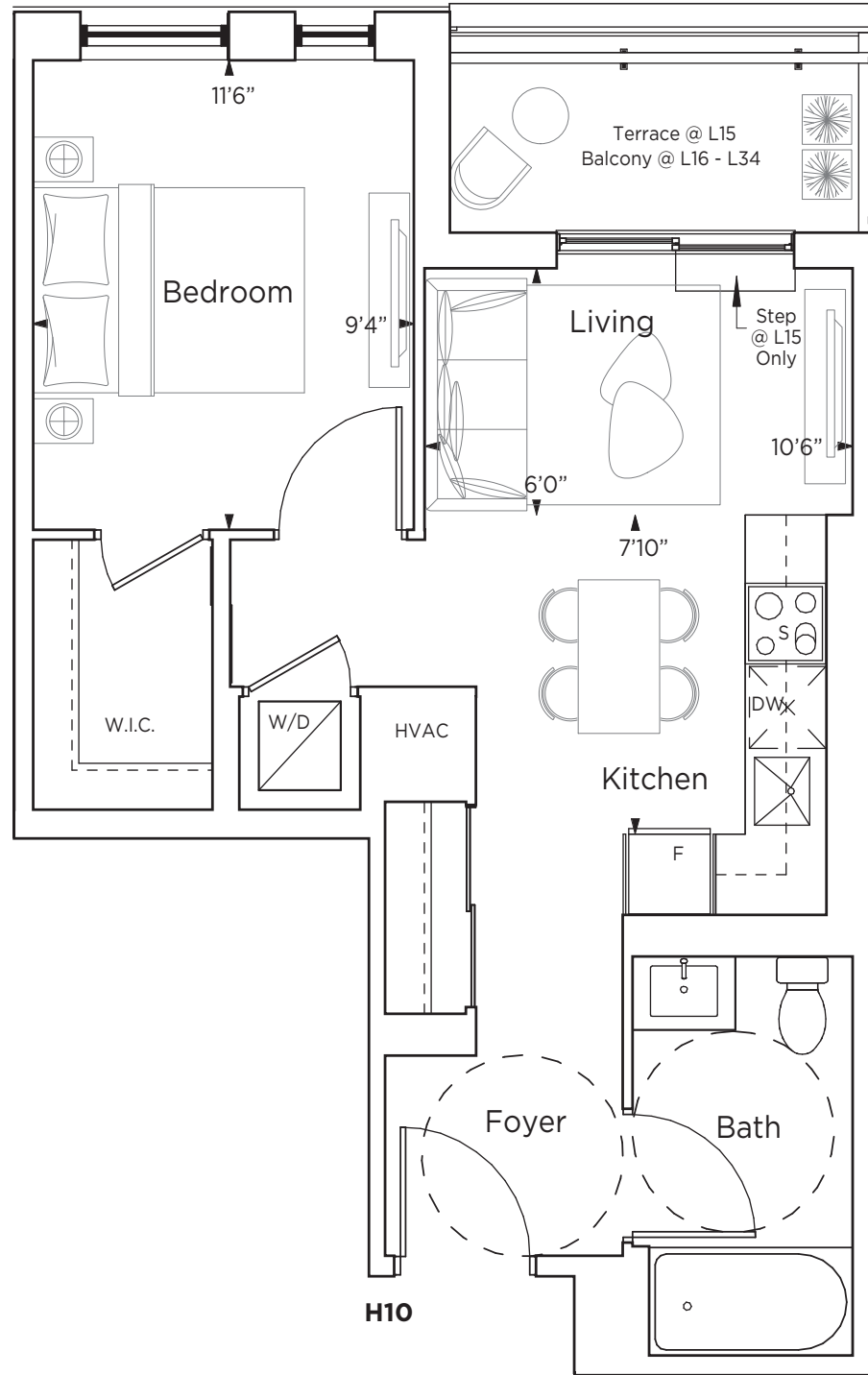

Tower A
LEVEL 15-34

ONE BED

COGNAC

528 SQ.FT. • 44 SQ.FT. BALCONY

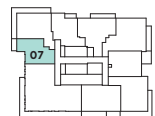
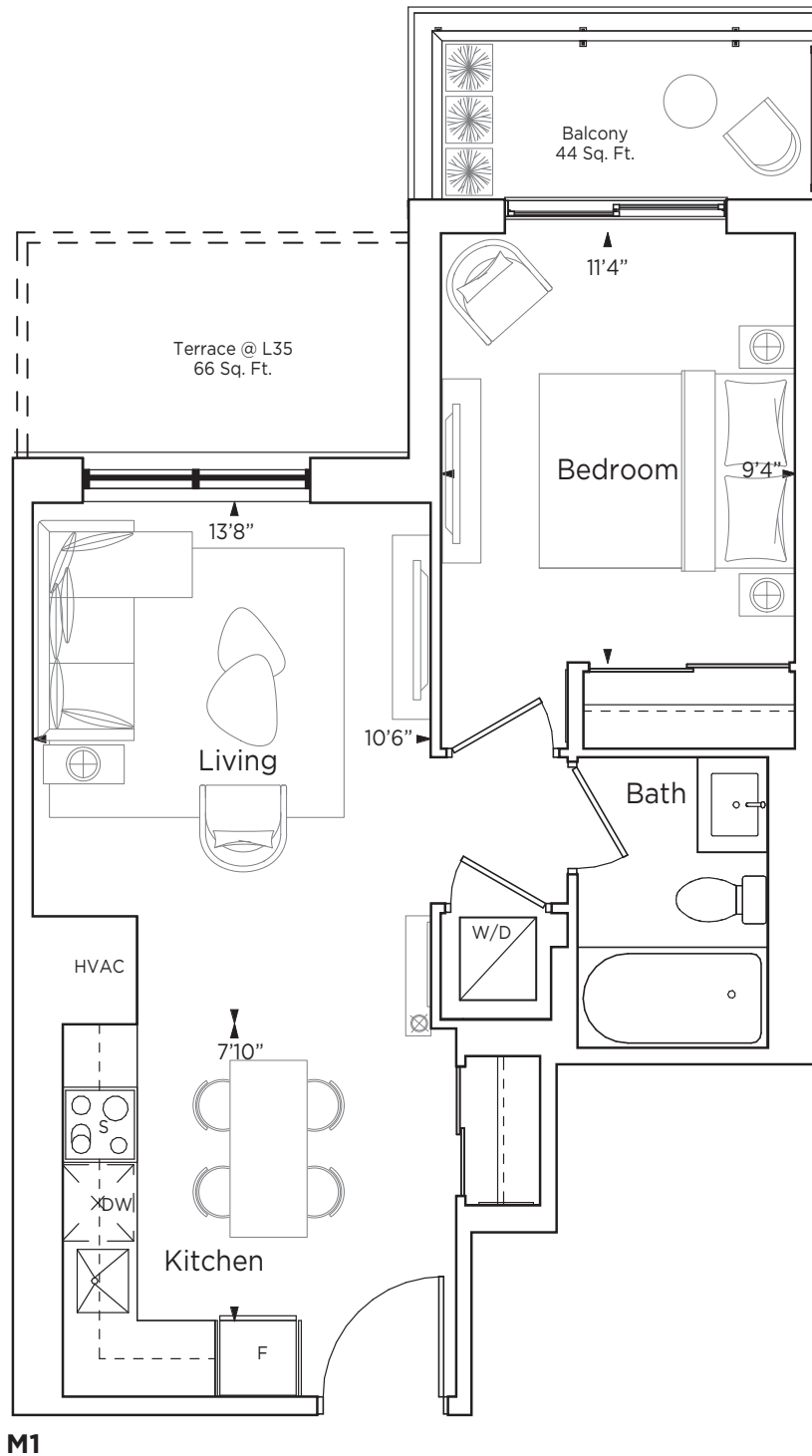

Tower A
LEVEL 36 - 37

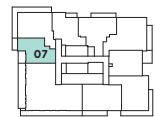

Tower A
LEVEL 35



Vincent
CONDOMINIUMS



ONE BED + DEN

DELACROIX

557 SQ.FT. • 35 SQ.FT. BALCONY



B29

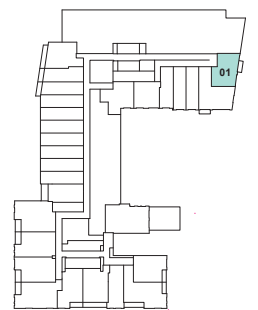

Tower A
LEVEL 2



Materials, specifications and floor plans are subject to change. All renderings are artist's concept. All floor plans are approximate dimensions. Actual usable floor space may vary from stated floor area. Balcony/terrace areas may vary. Windows, room/area dimensions & square feet may vary due to location within building. Furniture not included. E. & O. E.

ONE BED + DEN

DIAMOND

557 SQ.FT. • 647 SQ.FT. TERRACE

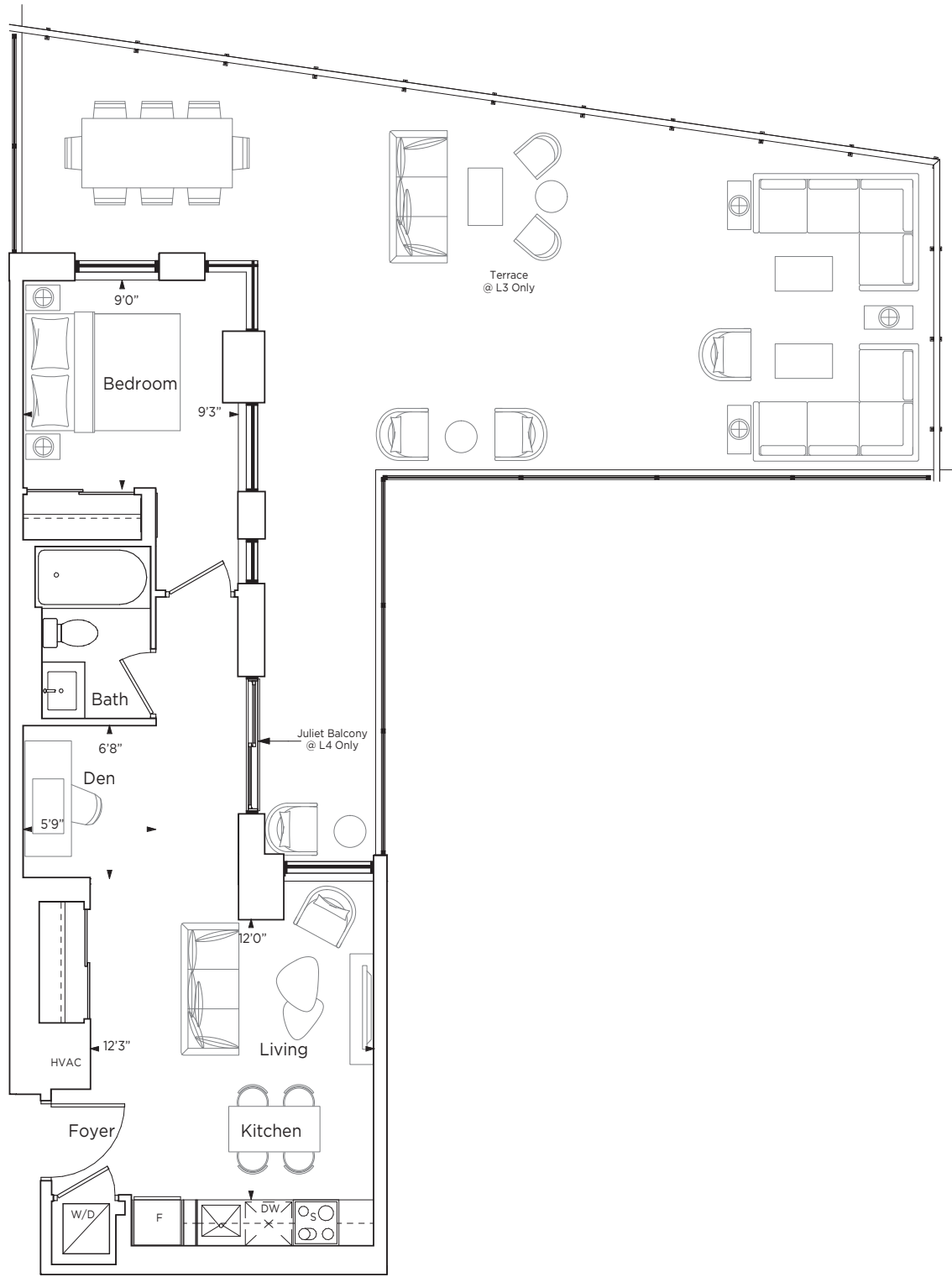

C9

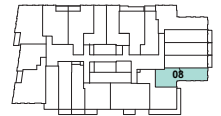

Tower A
LEVEL 4



Tower A
LEVEL 3



Vincent
CONDOMINIUMS



Materials, specifications and floor plans are subject to change. All renderings are artist's concept. All floor plans are approximate dimensions. Actual usable floor space may vary from stated floor area. Balcony/terrace areas may vary. Windows, room/area dimensions & square feet may vary due to location within building. Furniture not included. E. & O. E.

ONE BED + DEN

DOLOMITES

561 SQ.FT.

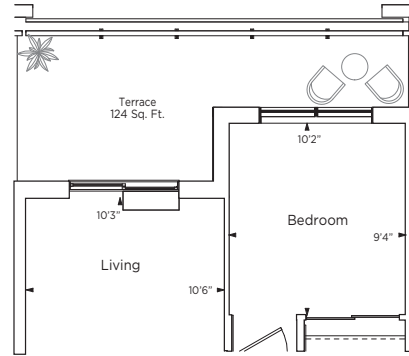
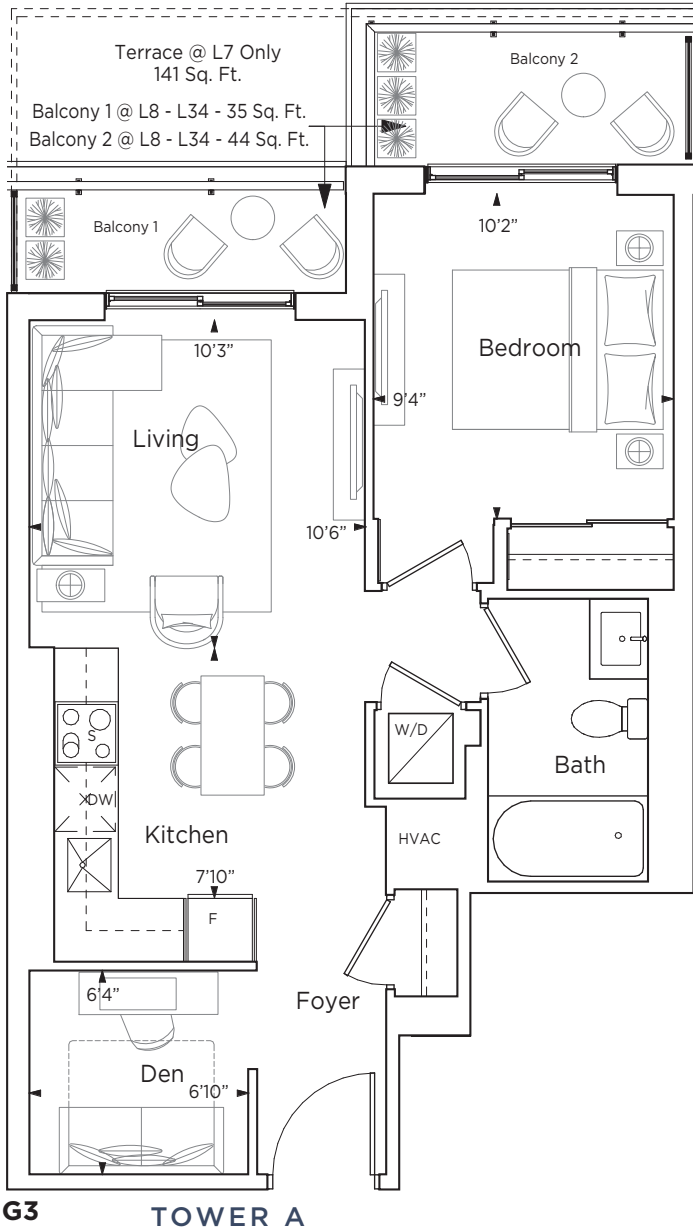

TOWER B

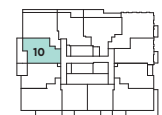
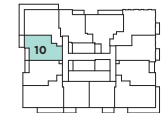
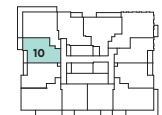
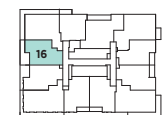
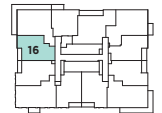
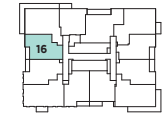
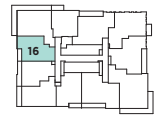
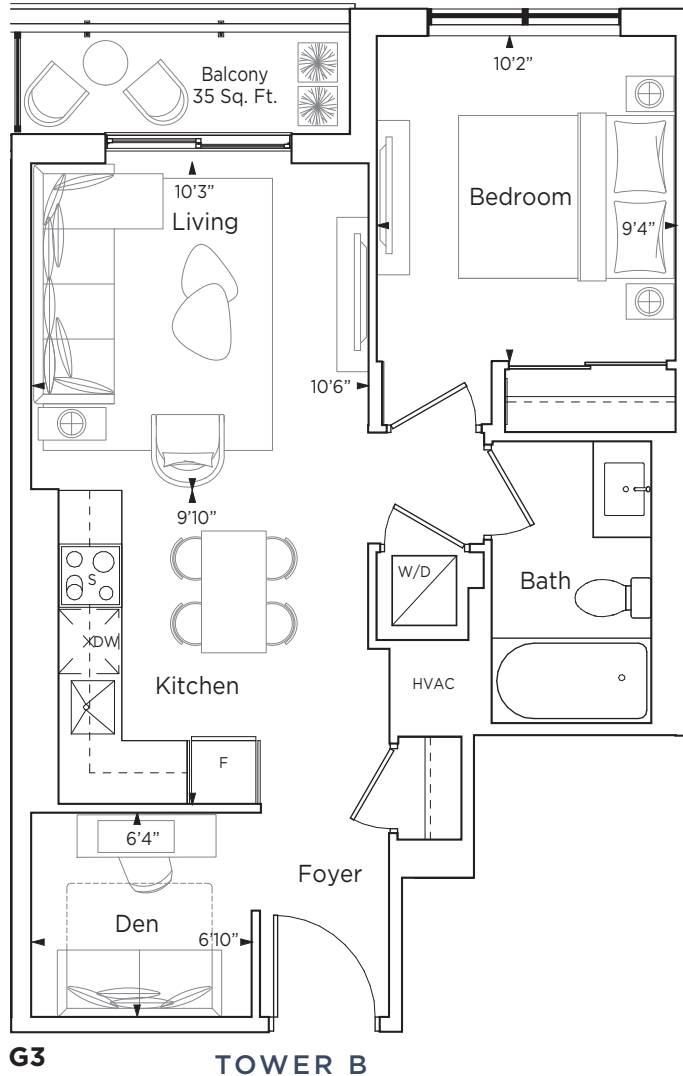

Vincent
CONDOMINIUMS



Materials, specifications and floor plans are subject to change. All renderings are artist's concept. All floor plans are approximate dimensions. Actual usable floor space may vary from stated floor area. Balcony/terrace areas may vary. Windows, room/area dimensions & square feet may vary due to location within building. Furniture not included. E. & O. E.

ONE BED + DEN

ESPRIT

568 SQ.FT. • 36 SQ.FT. BALCONY @ LEVEL 8-37

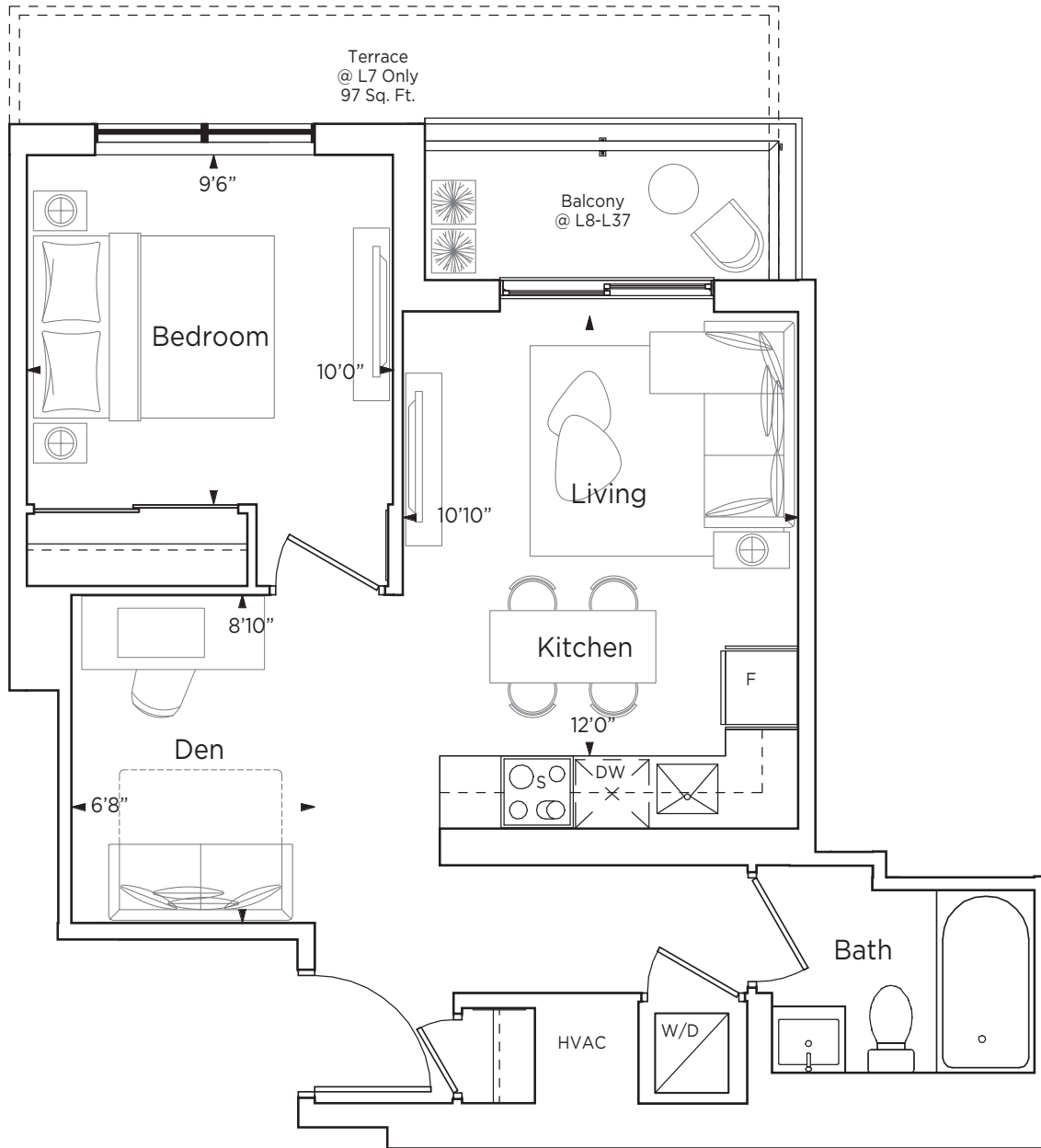

Tower A
LEVEL 35-37



Tower A
LEVEL 8-34

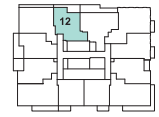

Tower A
LEVEL 7



Vincent
CONDOMINIUMS



Materials, specifications and floor plans are subject to change. All renderings are artist's concept. All floor plans are approximate dimensions. Actual usable floor space may vary from stated floor area. Balcony/terrace areas may vary. Windows, room/area dimensions & square feet may vary due to location within building. Furniture not included. E. & O. E.

ONE BED + DEN

FARO

571 SQ.FT. • 90 SQ.FT. TERRACE

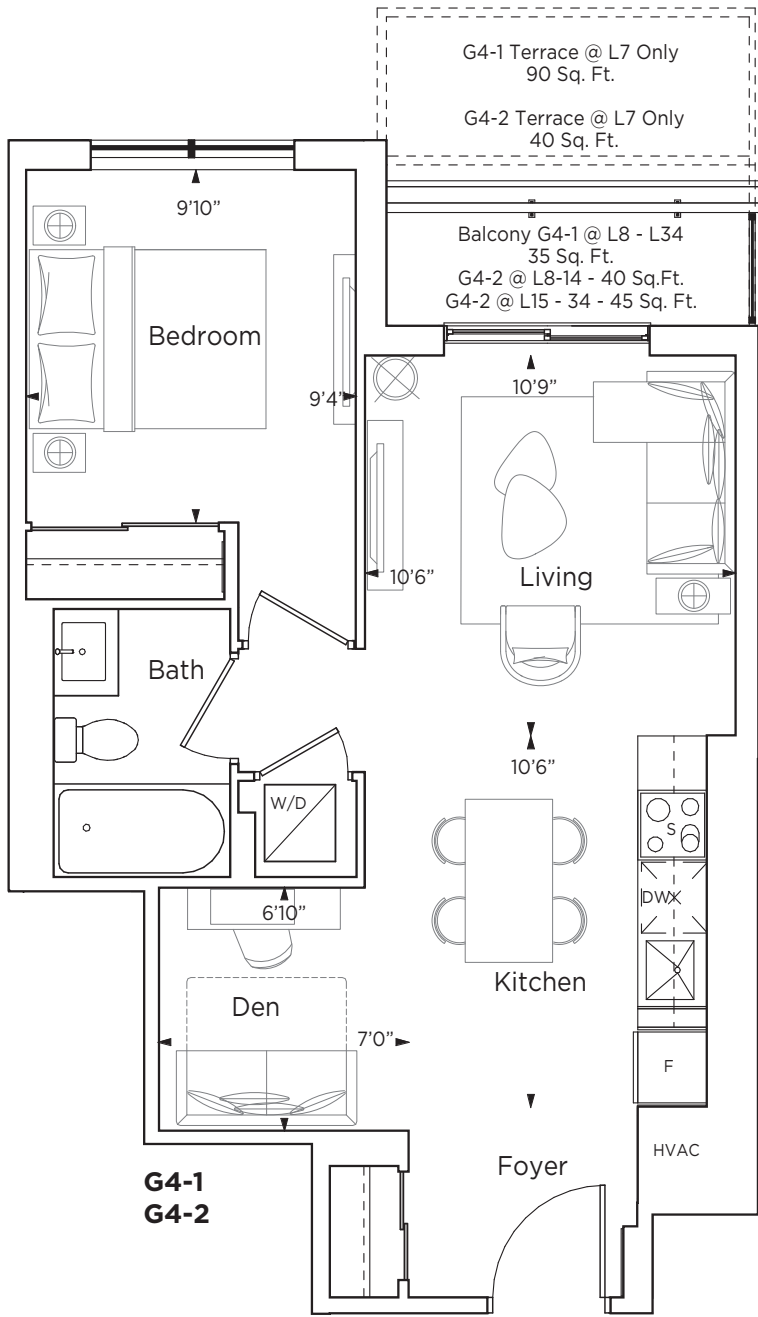

TOWER A

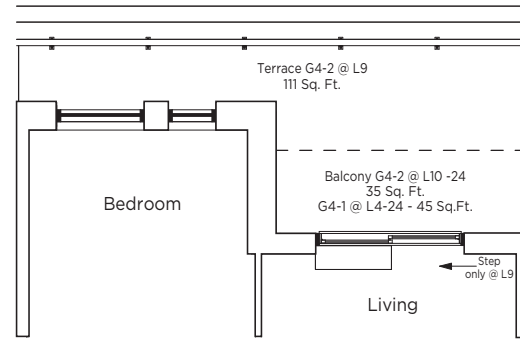

TERRACE PLAN
SUITE G4-2 AT LEVEL 9

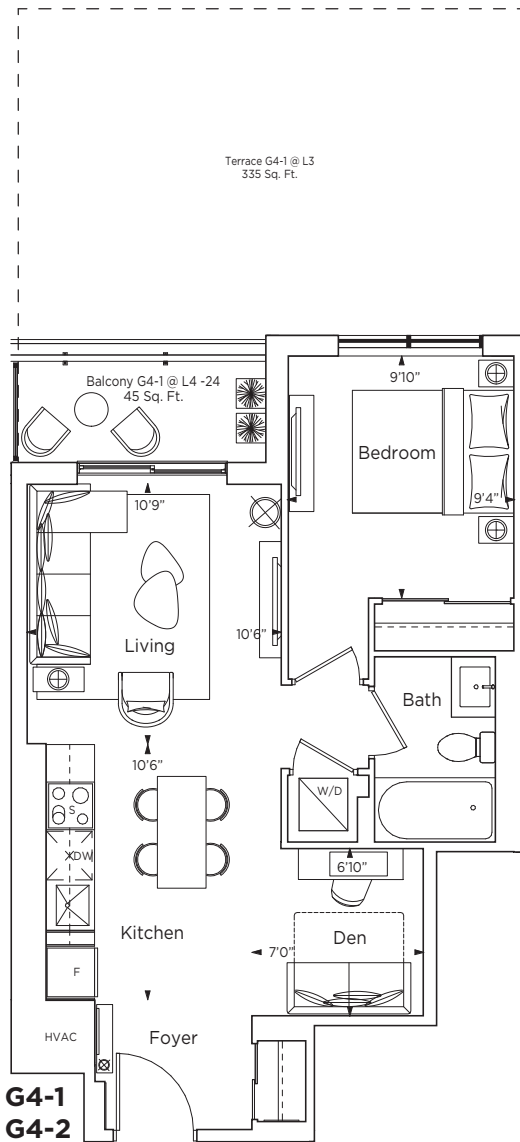

TOWER B



Tower B
LEVEL 15 - 24

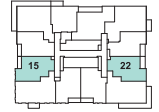

Tower B
LEVEL 10 - 14

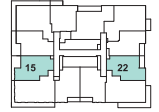

Tower B
LEVEL 9

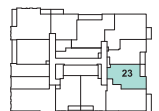

Tower B
LEVEL 7 - 8

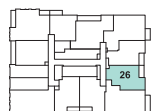

Tower B
LEVEL 6

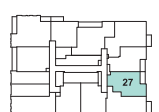

Tower B
LEVEL 5

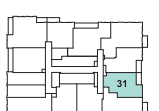

Tower B
LEVEL 4

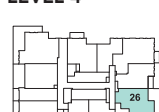

Tower B
LEVEL 3

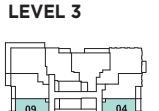

Tower A
LEVEL 15-34

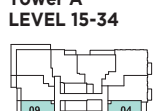

Tower A
LEVEL 8-14

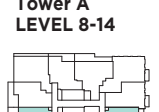

Tower A
LEVEL 7



Vincent
CONDOMINIUMS



ONE BED + DEN

FEDORA

595 SQ.FT. • 80 SQ.FT. TERRACE - TOWER A
577 SQ.FT. • 80 SQ.FT. BALCONY • 200 SQ.FT. TERRACE - TOWER B

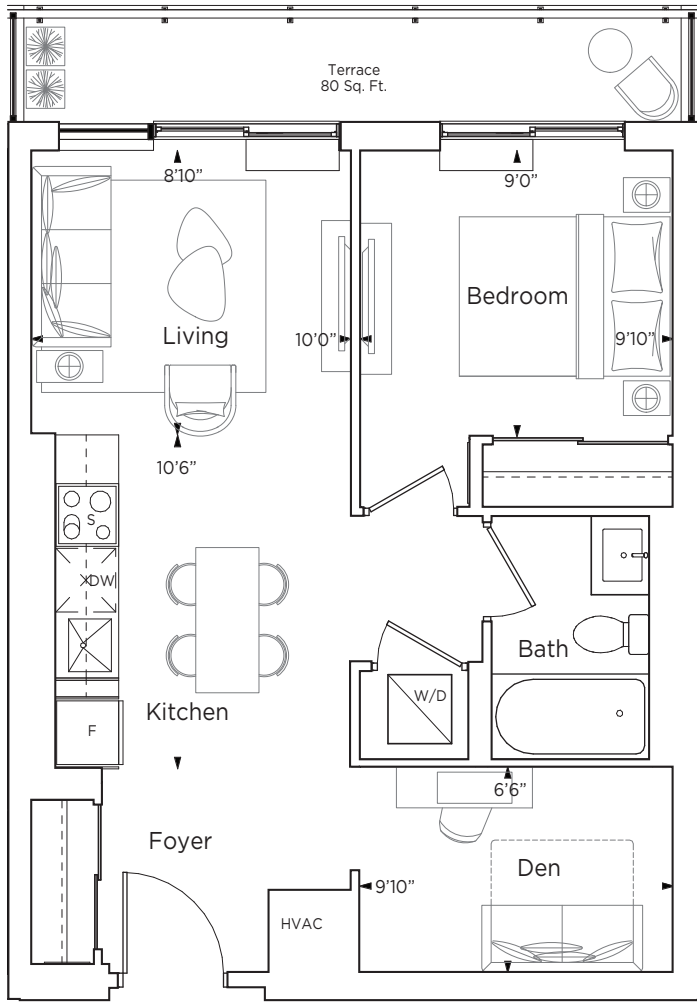

C19-1

TOWER A
595 SQ.FT.

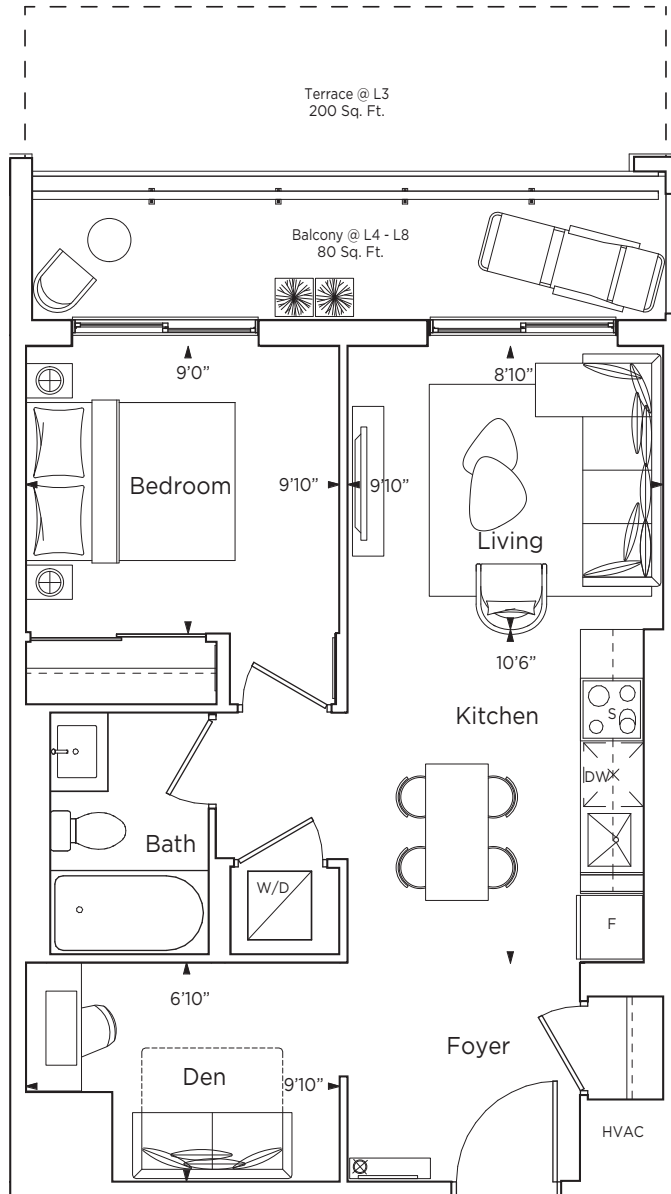

C19-2

TOWER B
577 SQ.FT.

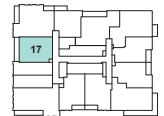

Tower B
LEVEL 7 - 8



Tower B
LEVEL 6

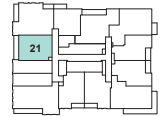

Tower B
LEVEL 5

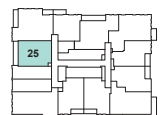

Tower B
LEVEL 4

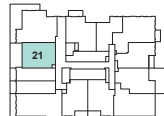

Tower B
LEVEL 3



Tower A
LEVEL 6



Vincent
CONDOMINIUMS



Materials, specifications and floor plans are subject to change. All renderings are artist's concept. All floor plans are approximate dimensions. Actual usable floor space may vary from stated floor area. Balcony/terrace areas may vary. Windows, room/area dimensions & square feet may vary due to location within building. Furniture not included. E. & O. E.

ONE BED + DEN

GENEVA

580 SQ.FT.

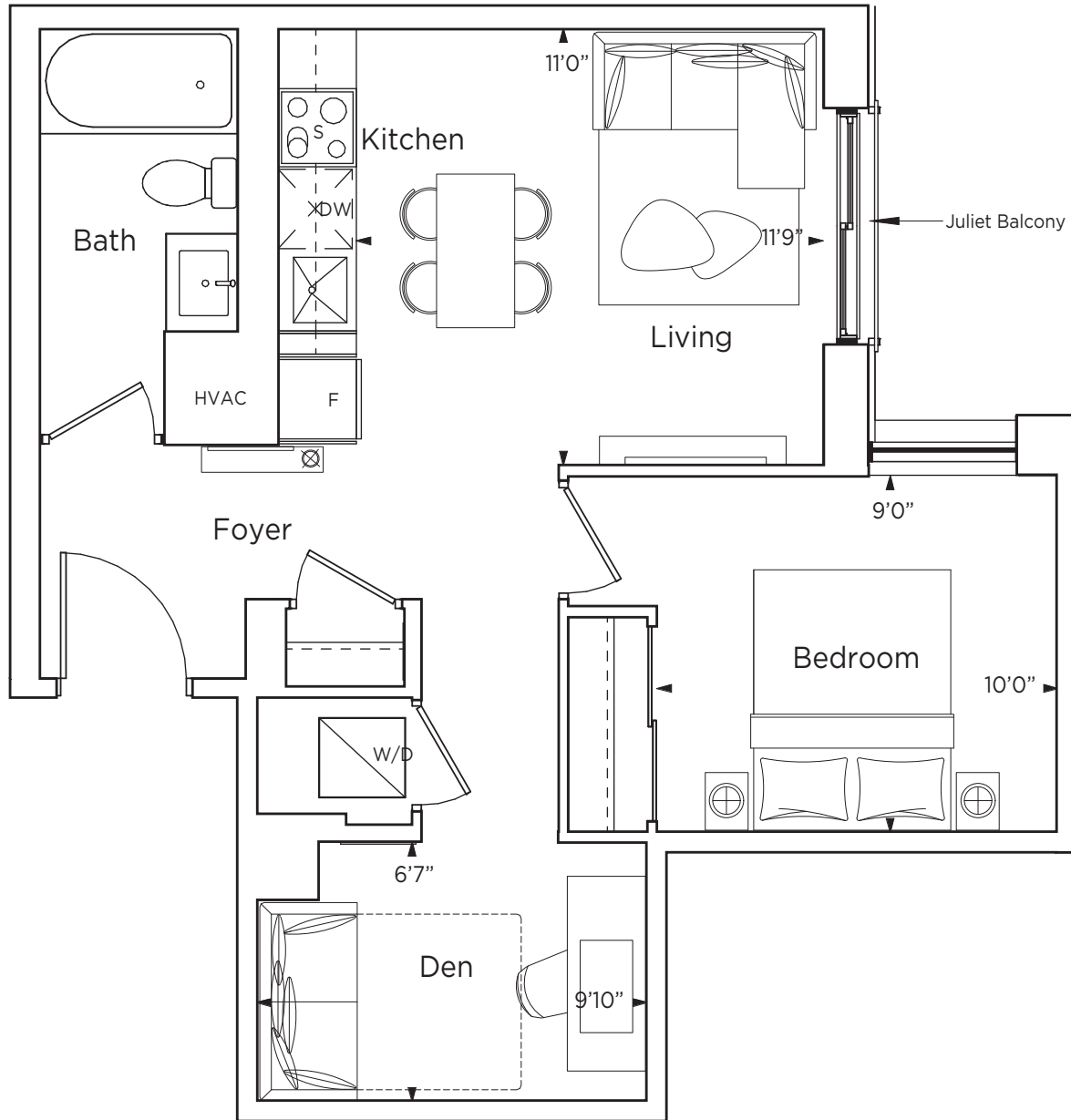

B24

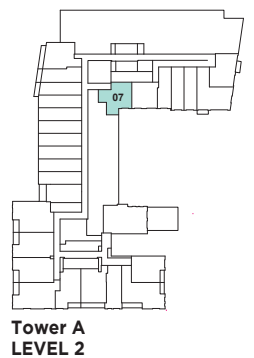

Materials, specifications and floor plans are subject to change. All renderings are artist's concept. All floor plans are approximate dimensions. Actual usable floor space may vary from stated floor area. Balcony/terrace areas may vary. Windows, room/area dimensions & square feet may vary due to location within building. Furniture not included. E. & O. E.

ONE BED + DEN

HAMBURG

590 SQ.FT. • 77 SQ.FT. BALCONY

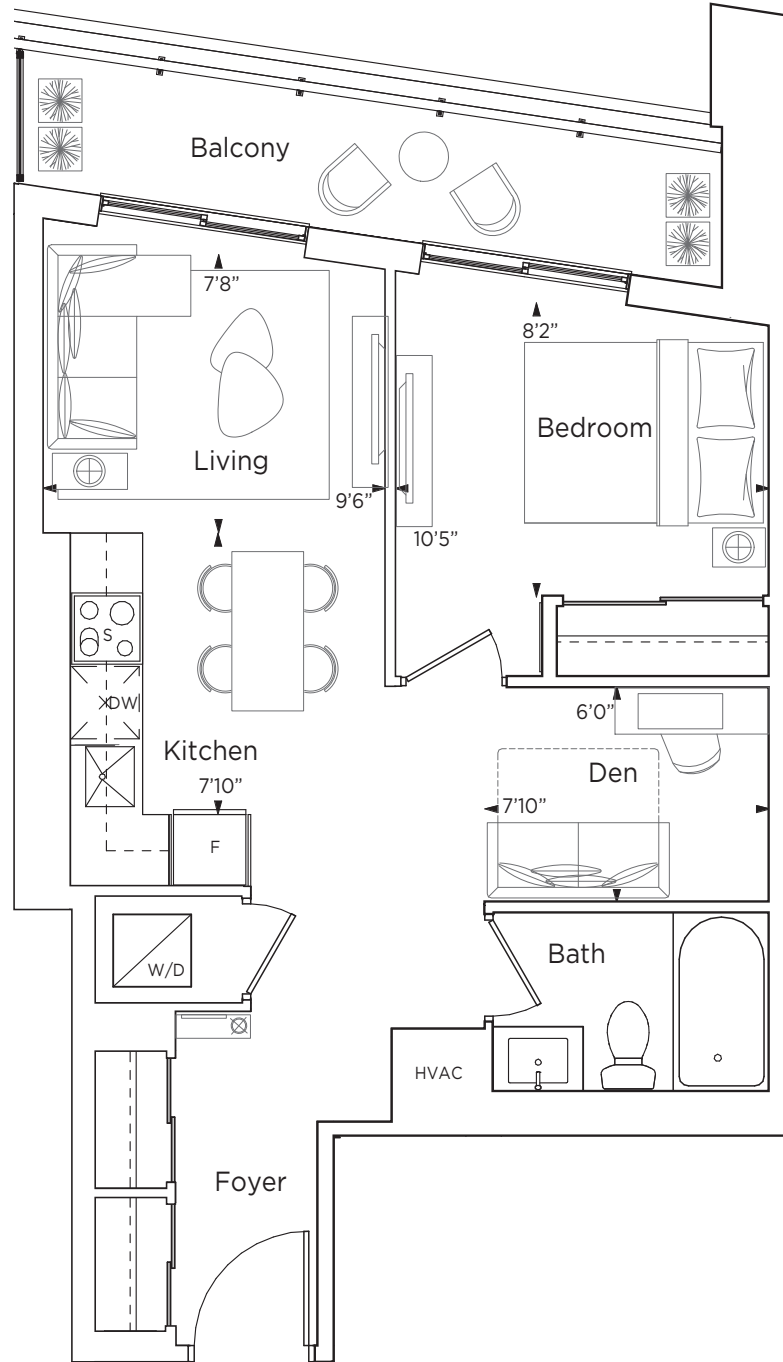

B1

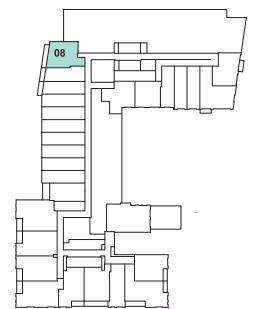

Tower A
LEVEL 2



Vincent
CONDOMINIUMS



Materials, specifications and floor plans are subject to change. All renderings are artist's concept. All floor plans are approximate dimensions. Actual usable floor space may vary from stated floor area. Balcony/terrace areas may vary. Windows, room/area dimensions & square feet may vary due to location within building. Furniture not included. E. & O. E.

ONE BED + DEN

HAVANA

593 SQ.FT. • 33 SQ.FT. BALCONY

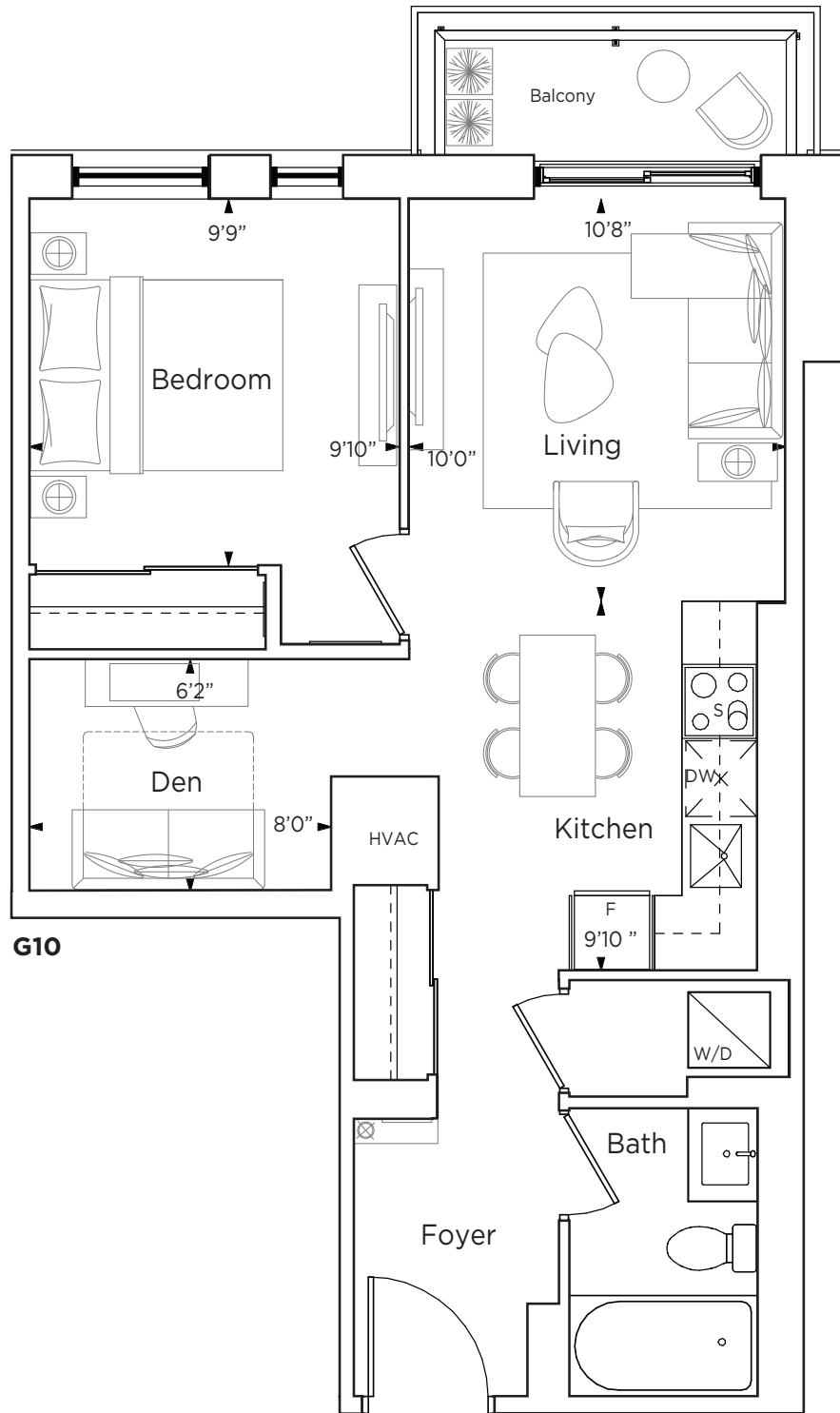

Vincent
CONDOMINIUMS

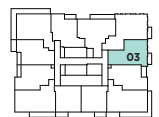

Tower A
LEVEL 7 - 14

Materials, specifications and floor plans are subject to change. All renderings are artist's concept. All floor plans are approximate dimensions. Actual usable floor space may vary from stated floor area. Balcony/terrace areas may vary. Windows, room/area dimensions & square feet may vary due to location within building. Furniture not included. E. & O. E.

ONE BED + DEN (BARRIER FREE)

HERRINGBONE

593 SQ.FT. • 85 SQ.FT. BALCONY

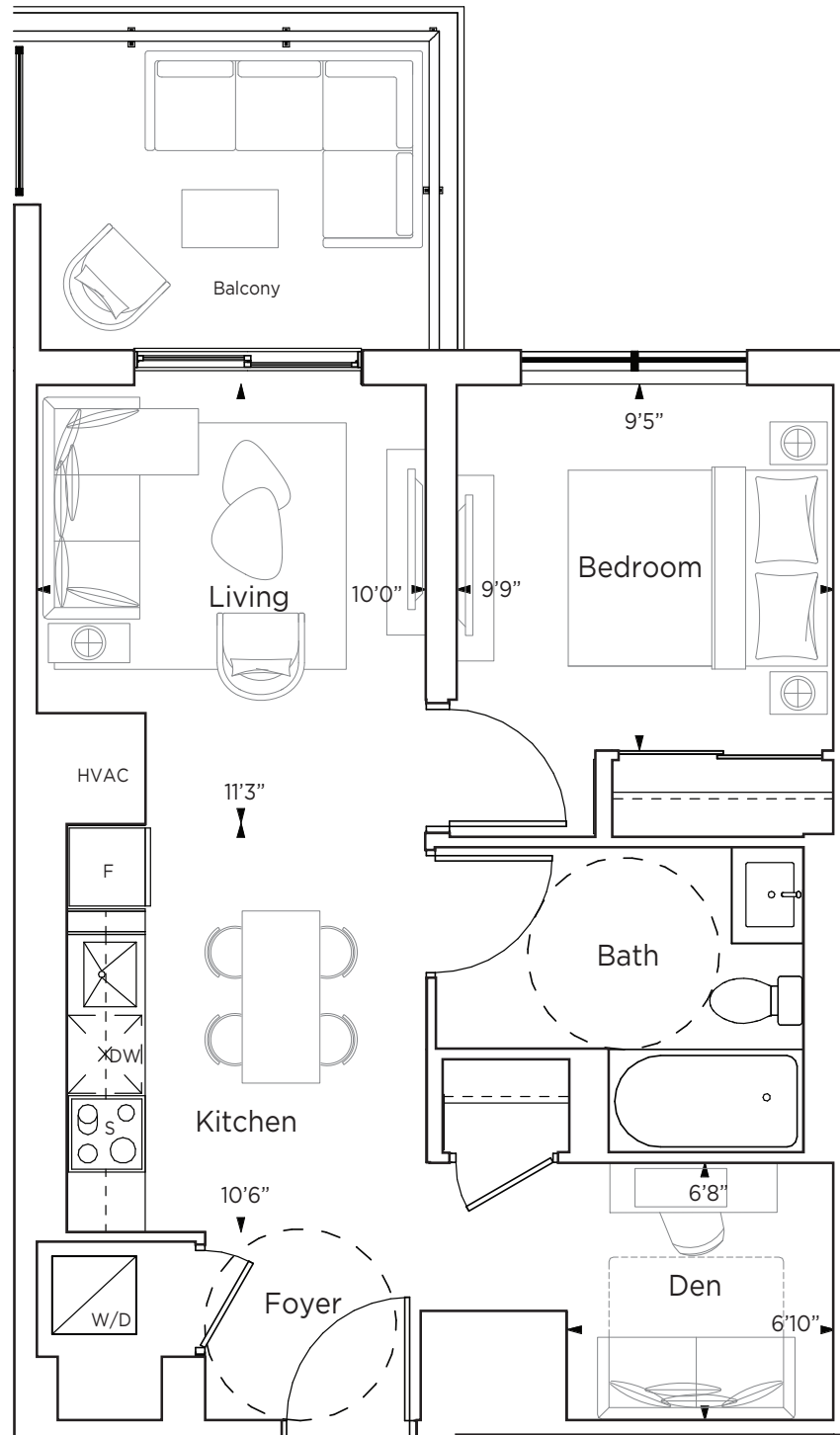

M6



Vincent
CONDOMINIUMS

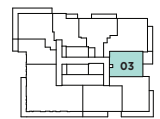

Tower A
LEVEL 35 - 37

Materials, specifications and floor plans are subject to change. All renderings are artist's concept. All floor plans are approximate dimensions. Actual usable floor space may vary from stated floor area. Balcony/terrace areas may vary. Windows, room/area dimensions & square feet may vary due to location within building. Furniture not included. E. & O. E.

ONE BED + DEN (BARRIER-FREE)

ISTANBUL

600 SQ.FT. • 80 SQ.FT. TERRACE

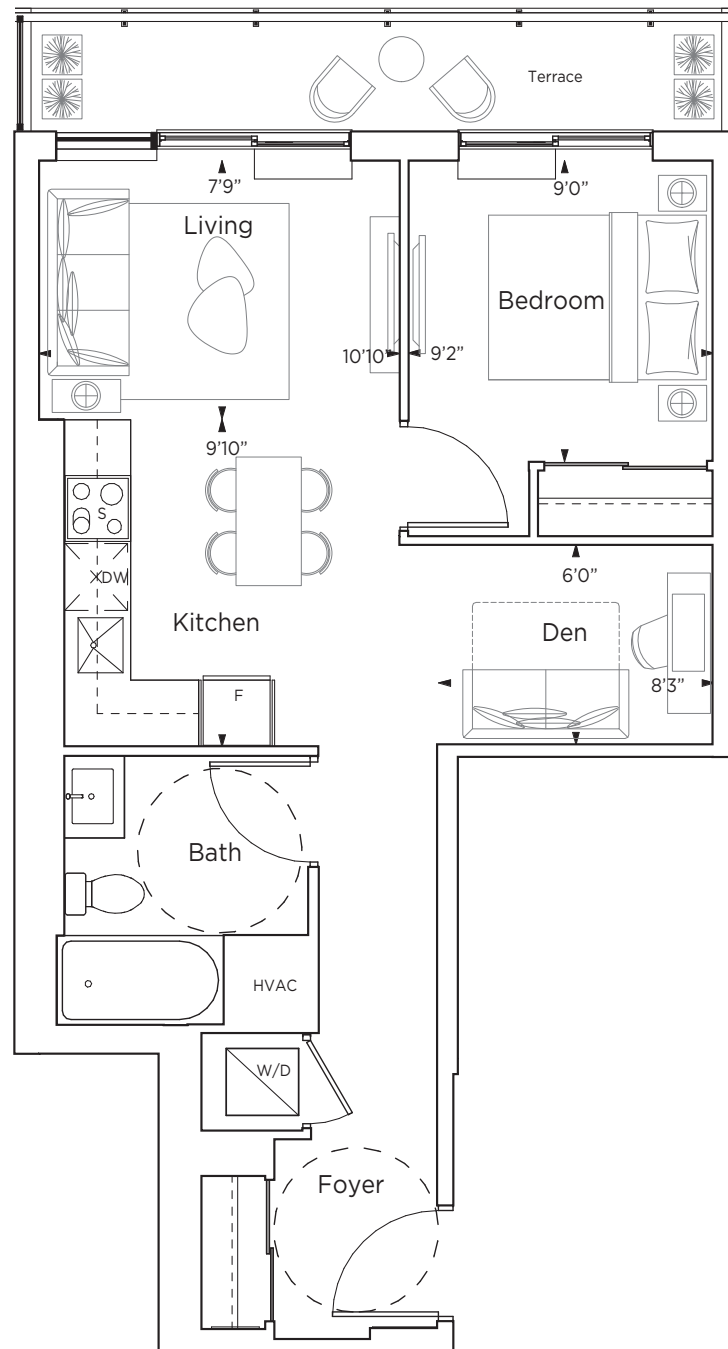

C16



Tower A
LEVEL 6

Materials, specifications and floor plans are subject to change. All renderings are artist's concept. All floor plans are approximate dimensions. Actual usable floor space may vary from stated floor area. Balcony/terrace areas may vary. Windows, room/area dimensions & square feet may vary due to location within building. Furniture not included. E. & O. E.

ONE BED + DEN (BARRIER-FREE)

JACQUARD

600 SQ.FT. • 44 SQ.FT. BALCONY / TERRACE

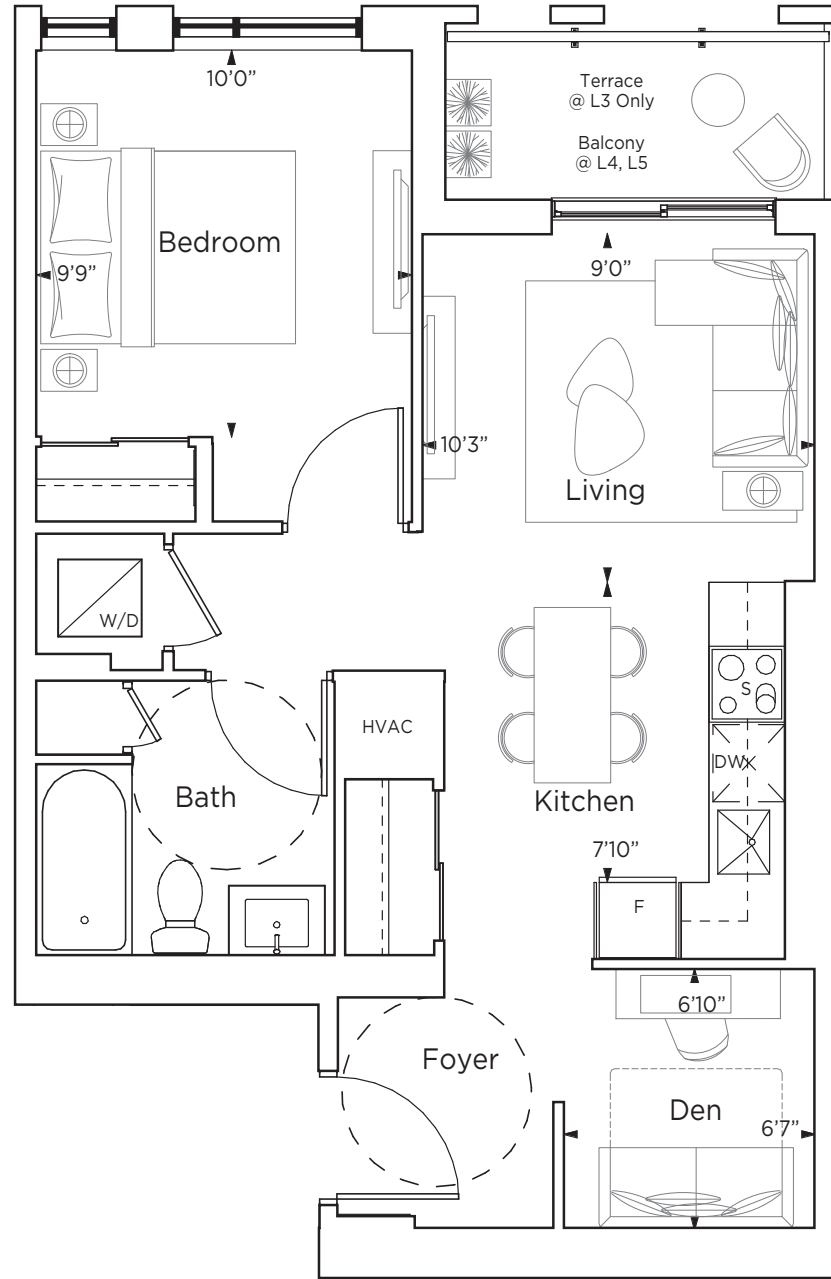

C3



Tower A
LEVEL 5



Tower A
LEVEL 4



Tower A
LEVEL 3



Vincent
CONDOMINIUMS



ONE BED + DEN (BARRIER-FREE)

KEY WEST

605 SQ.FT. • 77 SQ.FT. BALCONY • 88 SQ.FT. TERRACE

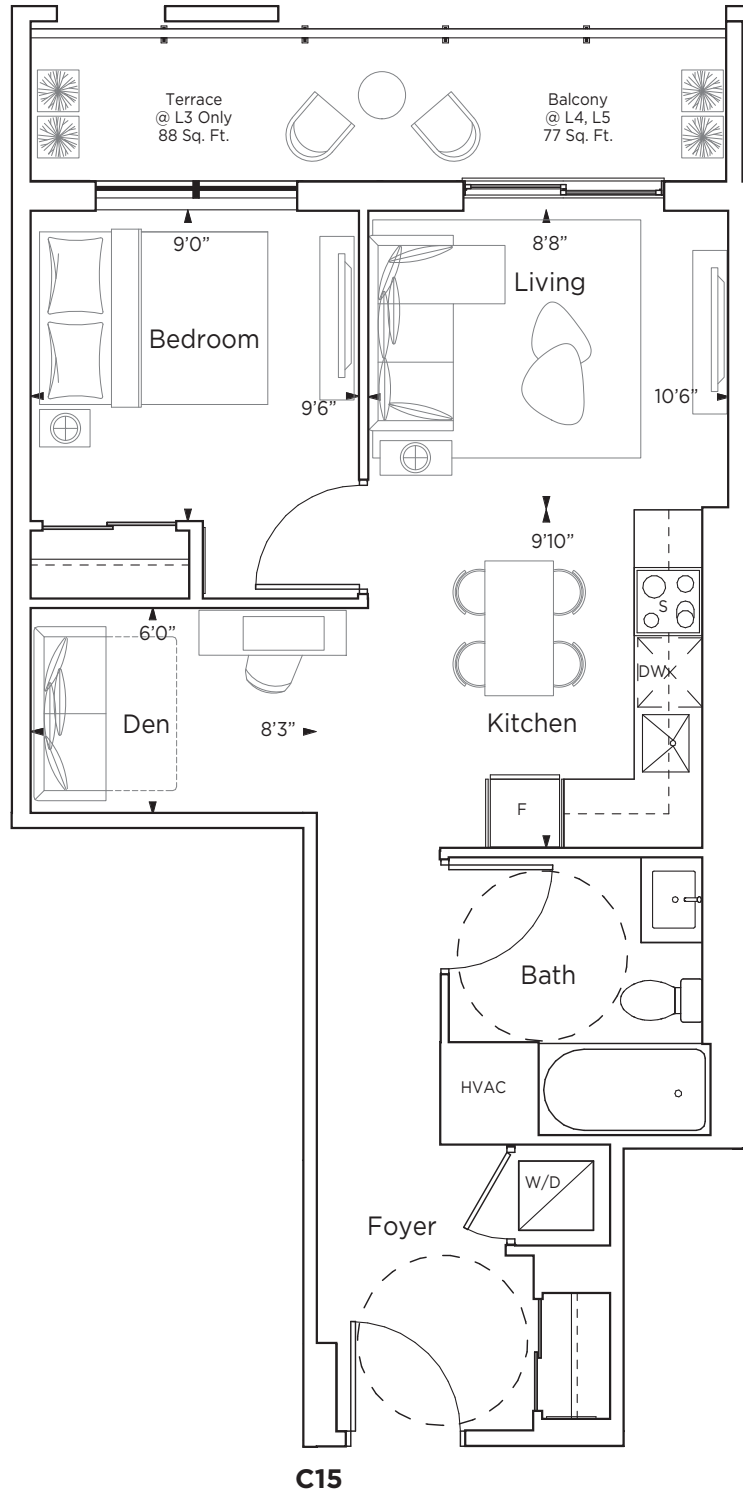

Tower A
LEVEL 5



Tower A
LEVEL 4

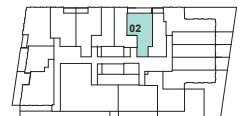

Tower A
LEVEL 3



Vincent
CONDOMINIUMS



Materials, specifications and floor plans are subject to change. All renderings are artist's concept. All floor plans are approximate dimensions. Actual usable floor space may vary from stated floor area. Balcony/terrace areas may vary. Windows, room/area dimensions & square feet may vary due to location within building. Furniture not included. E. & O. E.

ONE BED + DEN (BARRIER-FREE)

KINGSTON

608 SQ.FT. • 177 SQ.FT. BALCONY. • 514 SQ.FT. TERRACE

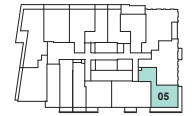
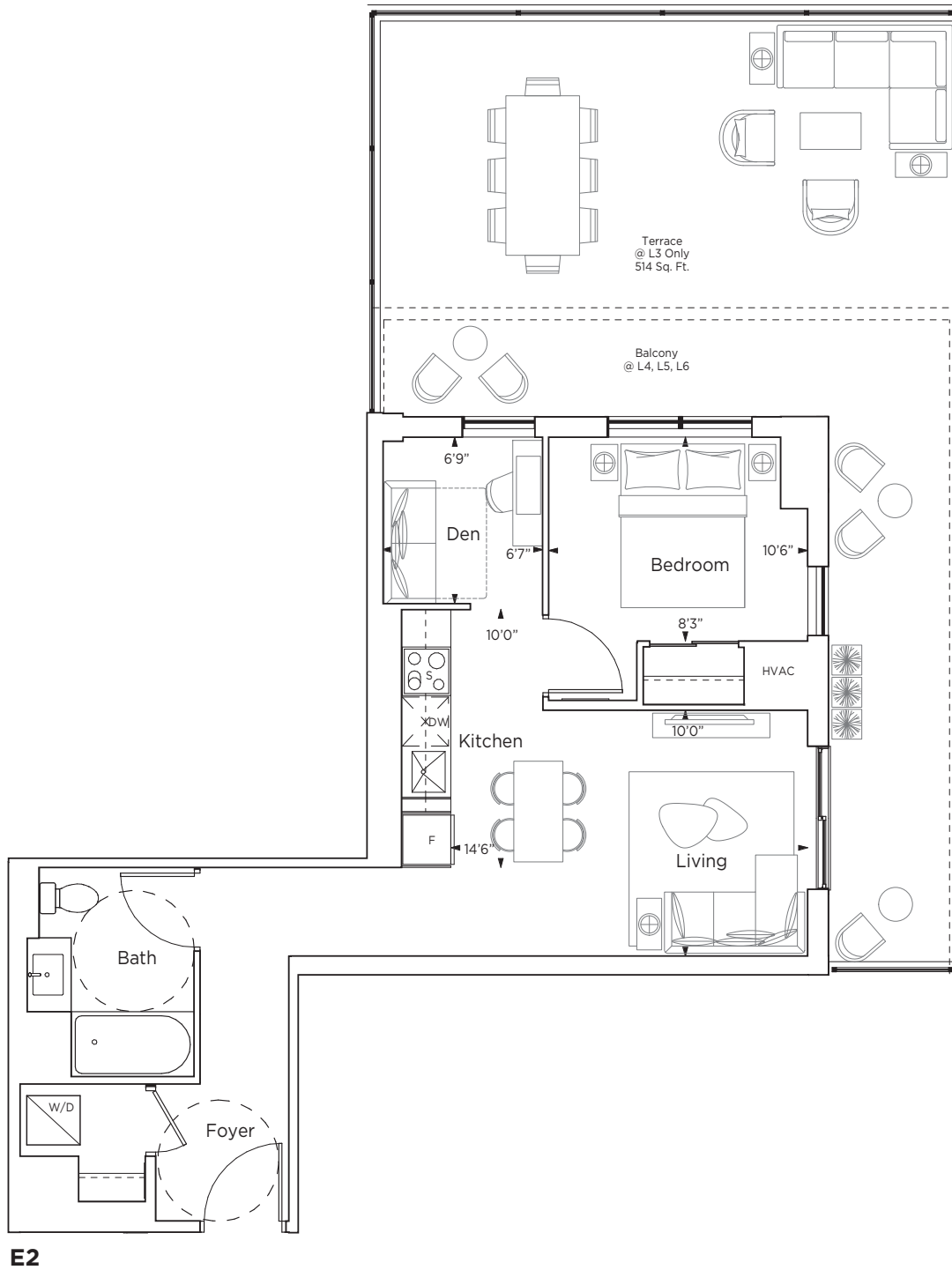

Tower A
LEVEL 6



Tower A
LEVEL 5



Tower A
LEVEL 4



Tower A
LEVEL 3



Vincent
CONDOMINIUMS



Materials, specifications and floor plans are subject to change. All renderings are artist's concept. All floor plans are approximate dimensions. Actual usable floor space may vary from stated floor area. Balcony/terrace areas may vary. Windows, room/area dimensions & square feet may vary due to location within building. Furniture not included. E. & O. E.

ONE BED + DEN

LANGOUSTE

638 SQ.FT. • 579 SQ.FT. TERRACE

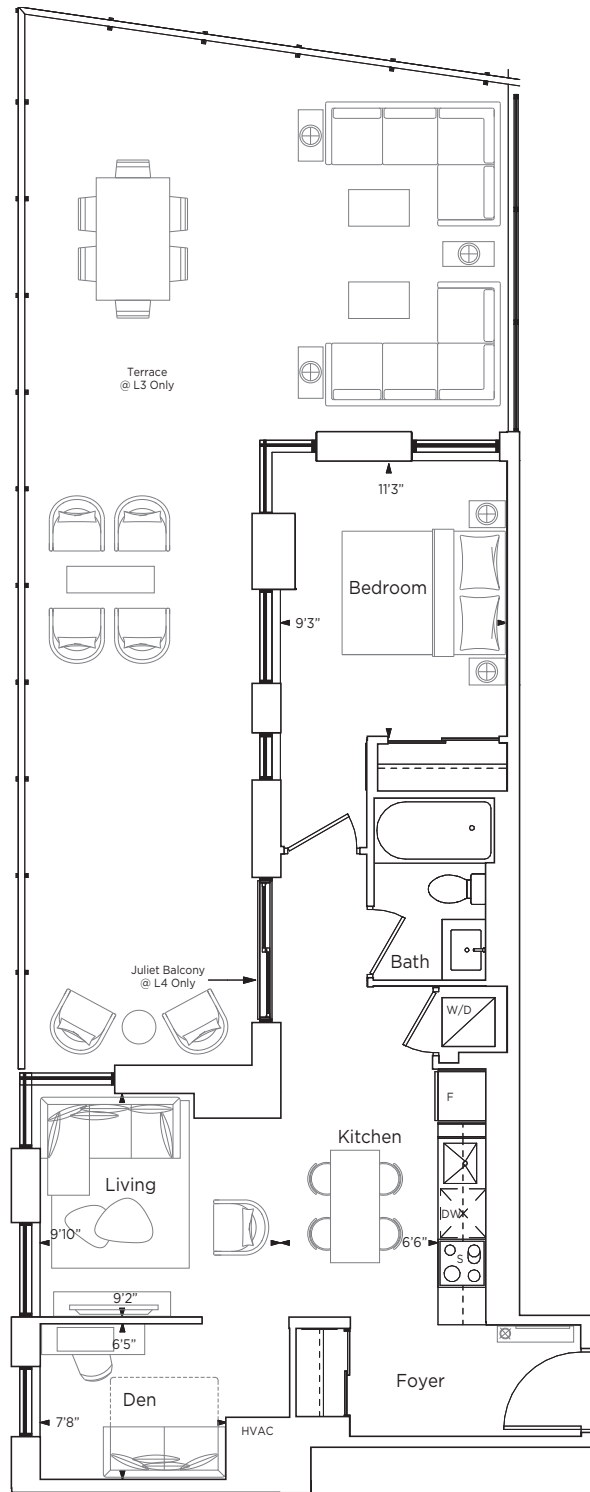

C13



Tower A
LEVEL 4

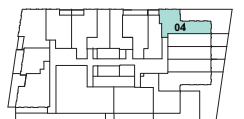

Tower A
LEVEL 3



Vincent
CONDOMINIUMS



Materials, specifications and floor plans are subject to change. All renderings are artist's concept. All floor plans are approximate dimensions. Actual usable floor space may vary from stated floor area. Balcony/terrace areas may vary. Windows, room/area dimensions & square feet may vary due to location within building. Furniture not included. E. & O. E.

ONE BED + DEN (BARRIER-FREE)

LAS VEGAS

655 SQ.FT. • 44 SQ.FT. BALCONY / TERRACE

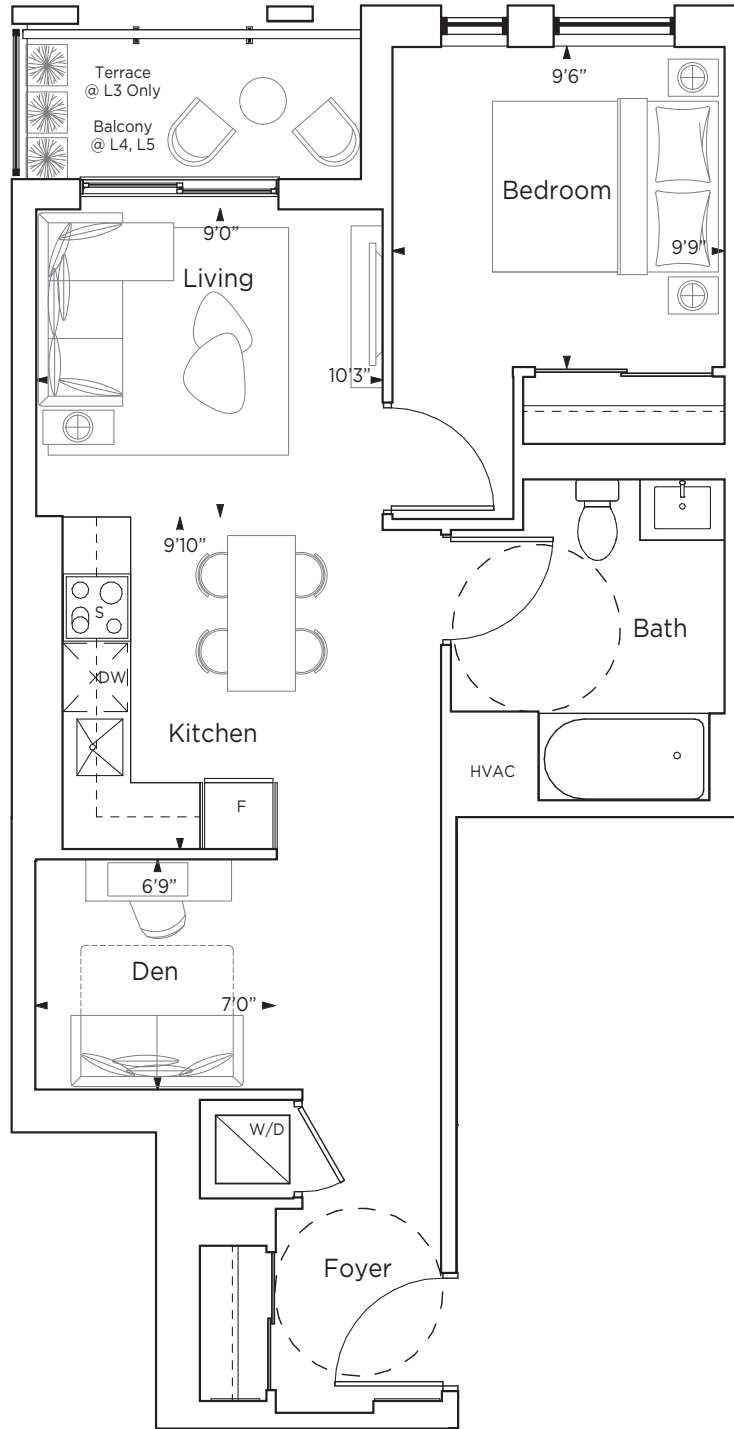

C2

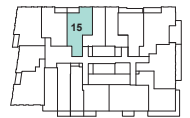

Tower A
LEVEL 5

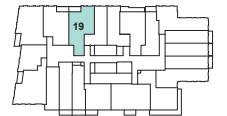

Tower A
LEVEL 4

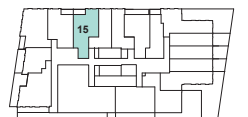

Tower A
LEVEL 3



Vincent
CONDOMINIUMS



Materials, specifications and floor plans are subject to change. All renderings are artist's concept. All floor plans are approximate dimensions. Actual usable floor space may vary from stated floor area. Balcony/terrace areas may vary. Windows, room/area dimensions & square feet may vary due to location within building. Furniture not included. E. & O. E.

TWO BED

LOS ANGELES

699 SQ.FT. • 77 SQ.FT. BALCONY • 165 SQ.FT. TERRACE

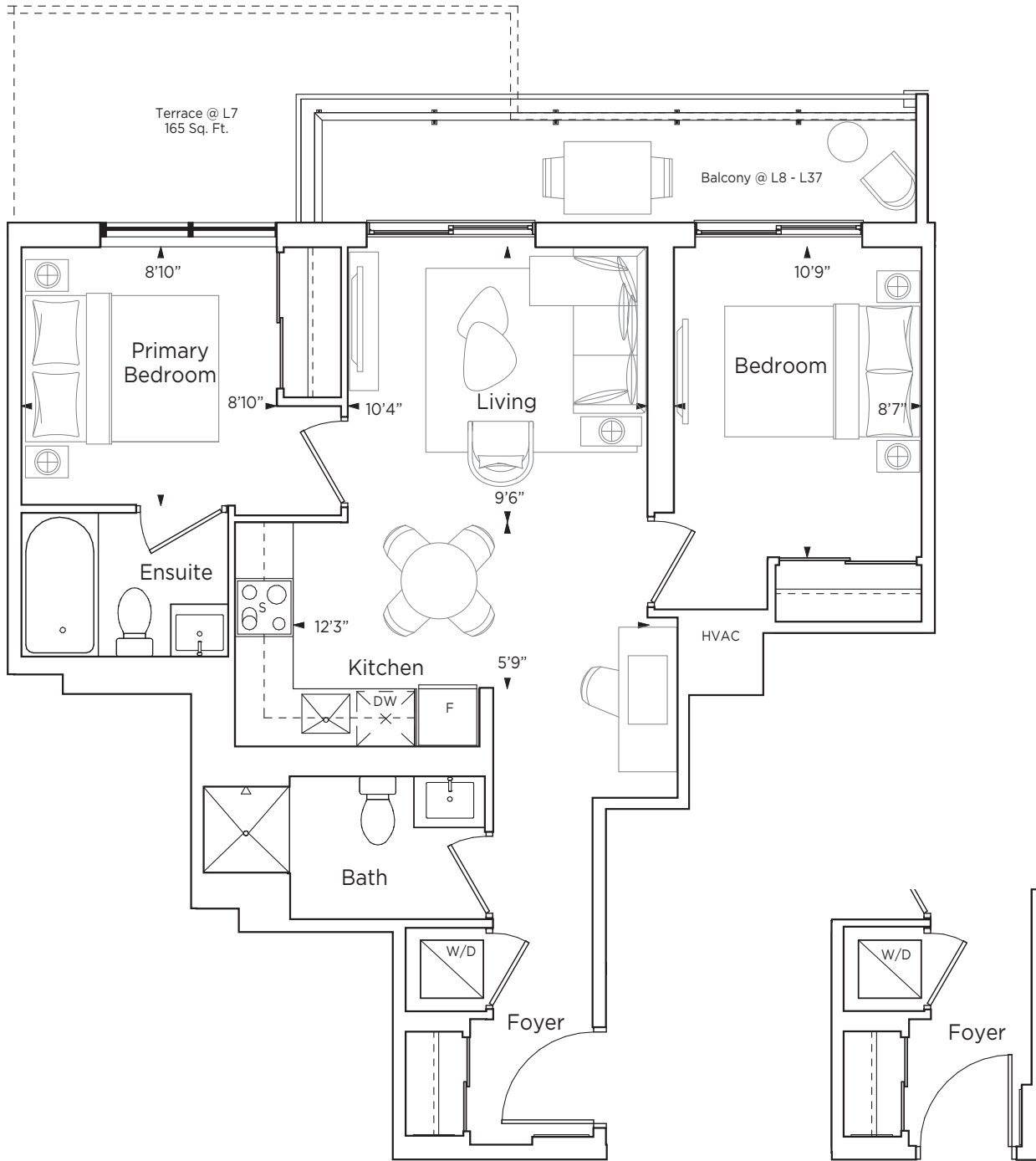

G12

ENTRANCE
AT LEVEL 35 - 37



Tower A
LEVEL 35 - 37



Tower A
LEVEL 15 - 34



Tower A
LEVEL 8 - 14



Tower A
LEVEL 7



Vincent
CONDOMINIUMS



Materials, specifications and floor plans are subject to change. All renderings are artist's concept. All floor plans are approximate dimensions. Actual usable floor space may vary from stated floor area. Balcony/terrace areas may vary. Windows, room/area dimensions & square feet may vary due to location within building. Furniture not included. E. & O. E.

TWO BED

LUXOR

704 SQ.FT. • 67 SQ.FT. TERRACE

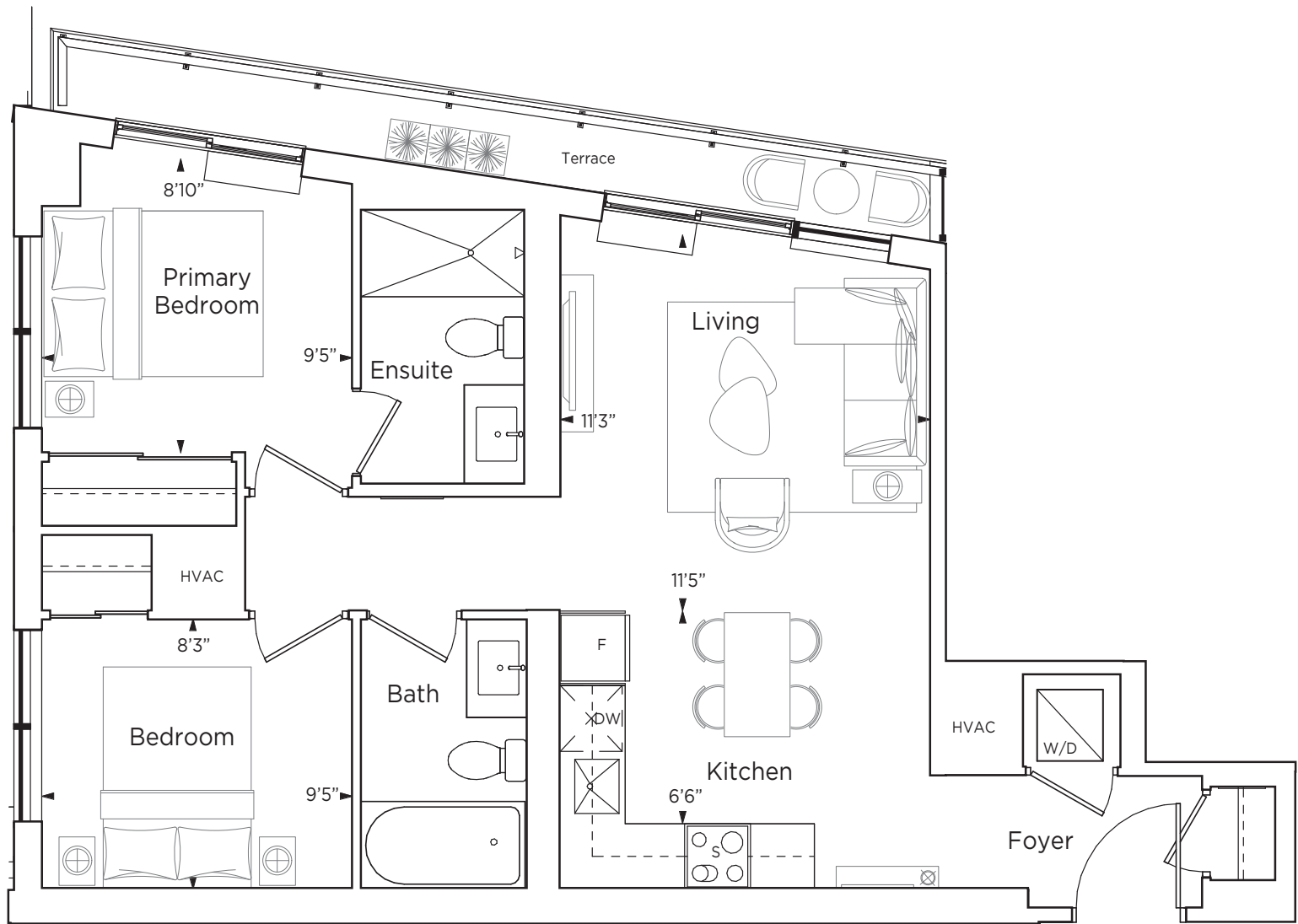

F5



Tower A
LEVEL 6

Materials, specifications and floor plans are subject to change. All renderings are artist's concept. All floor plans are approximate dimensions. Actual usable floor space may vary from stated floor area. Balcony/terrace areas may vary. Windows, room/area dimensions & square feet may vary due to location within building. Furniture not included. E. & O. E.

TWO BED

MAUI

706 SQ.FT. • 239 SQ.FT. BALCONY • 67 SQ.FT. TERRACE - TOWER A
706 SQ.FT. • 238 SQ.FT. BALCONY • 217 SQ.FT. TERRACE - TOWER B

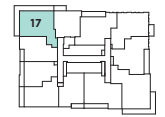
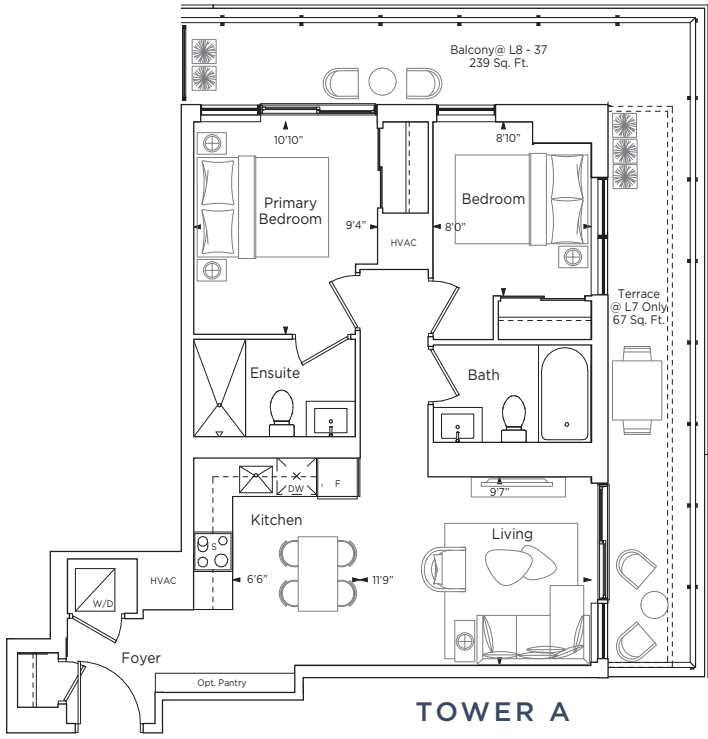
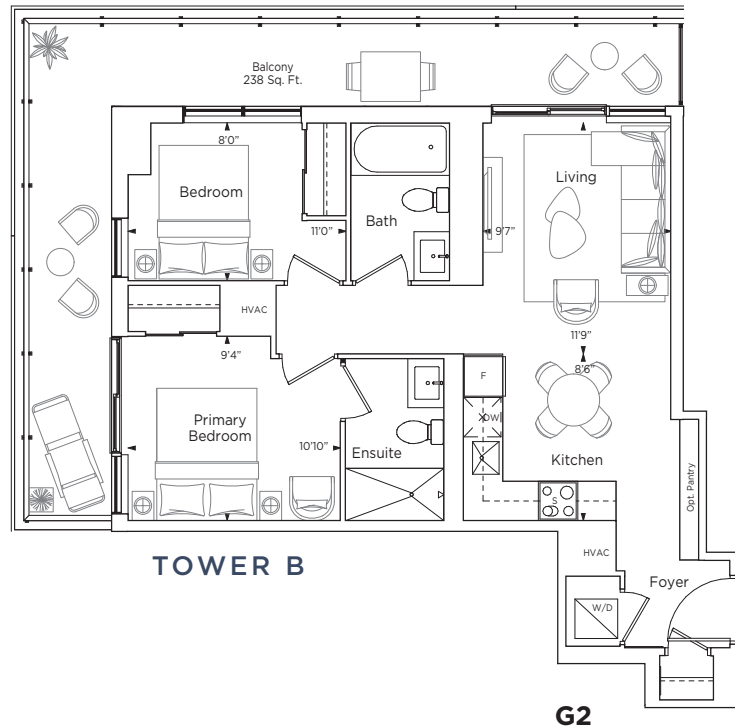
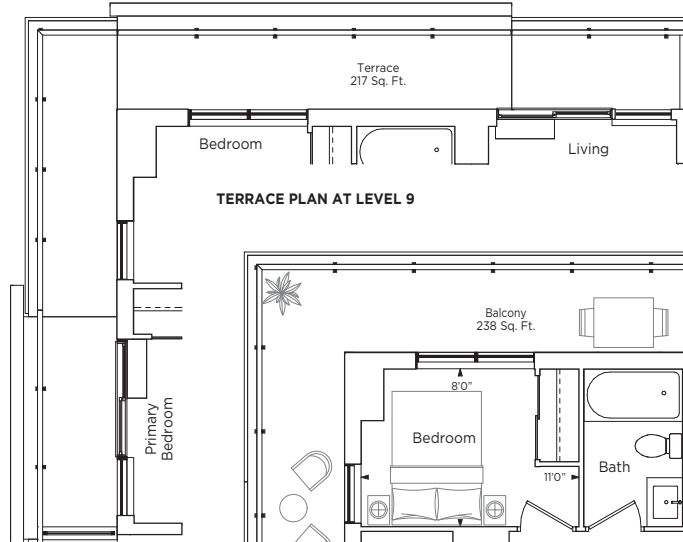

Tower B
LEVEL 25 - 27



Tower B
LEVEL 15 - 24

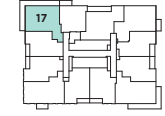

Tower B
LEVEL 10 - 14

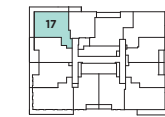

Tower B
LEVEL 9

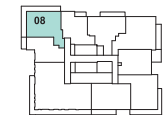

Tower A
LEVEL 35-37



Tower A
LEVEL 8-34

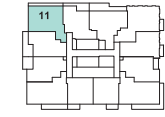

Tower A
LEVEL 7

G2

G2



Vincent
CONDOMINIUMS



Materials, specifications and floor plans are subject to change. All renderings are artist's concept. All floor plans are approximate dimensions. Actual usable floor space may vary from stated floor area. Balcony/terrace areas may vary. Windows, room/area dimensions & square feet may vary due to location within building. Furniture not included. E. & O. E.

TWO BED
MONACO
 706 SQ.FT.

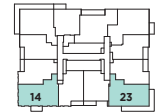
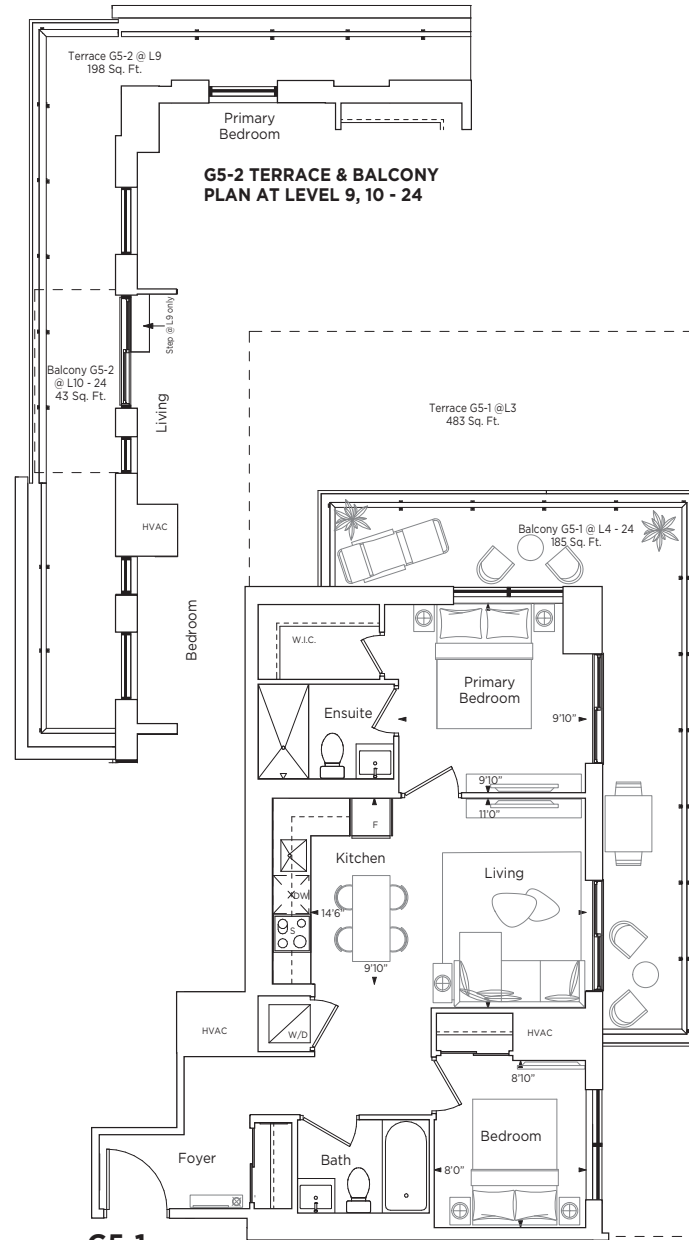
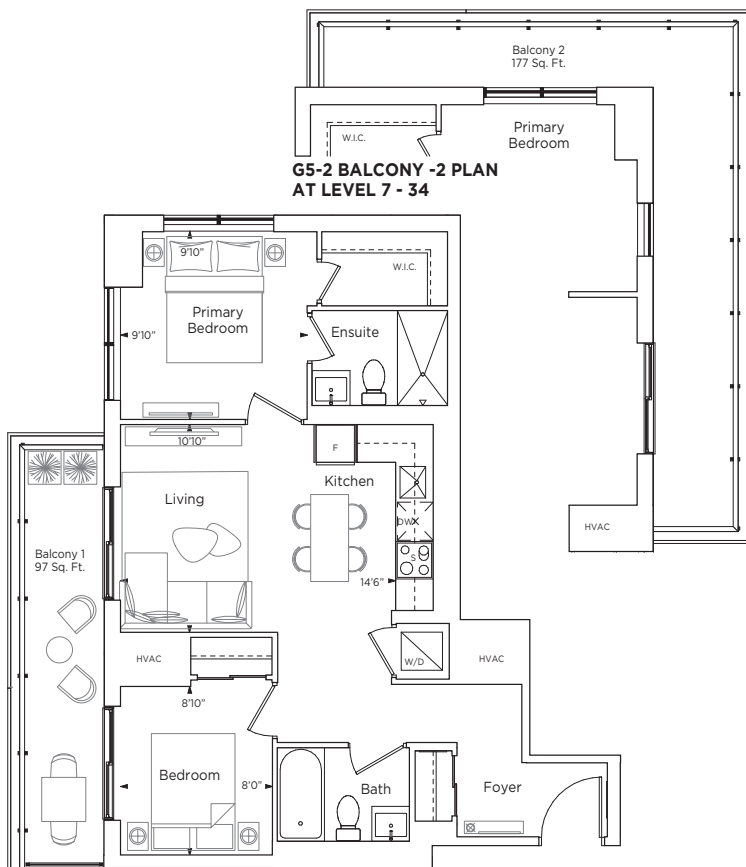

Tower B
 LEVEL 15 - 24



Tower B
 LEVEL 10 - 14

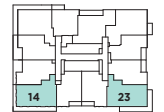

Tower B
 LEVEL 9

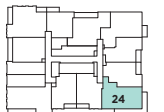

Tower B
 LEVEL 7 - 8

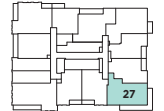

Tower B
 LEVEL 6

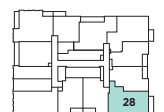

Tower B
 LEVEL 5

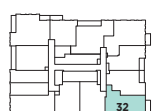

Tower B
 LEVEL 4

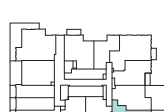

Tower B
 LEVEL 3



Tower A
 LEVEL 7 - 34



Materials, specifications and floor plans are subject to change. All renderings are artist's concept. All floor plans are approximate dimensions. Actual usable floor space may vary from stated floor area. Balcony/terrace areas may vary. Windows, room/area dimensions & square feet may vary due to location within building. Furniture not included. E. & O. E.

TWO BED

MONOGRAM

707 SQ.FT. • 47 SQ.FT. BALCONY / TERRACE

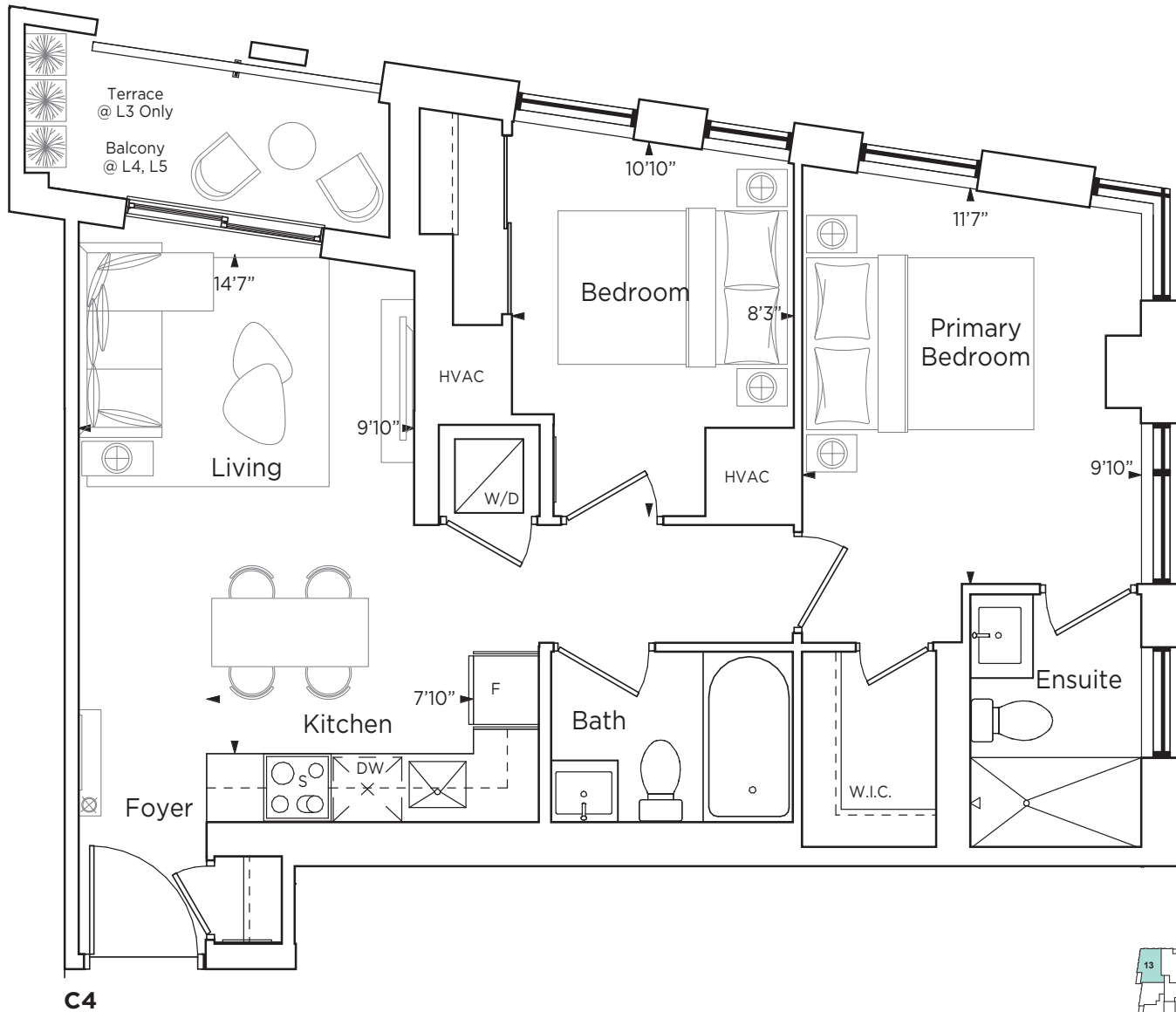

Tower A
LEVEL 5



Tower A
LEVEL 4



Tower A
LEVEL 3



Vincent
CONDOMINIUMS



TWO BED

MONTE CARLO

725 SQ. FT.

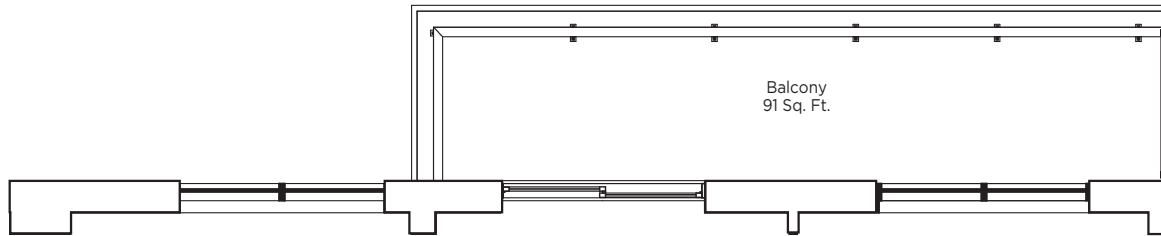

BALCONY PLAN AT LEVEL 35-37

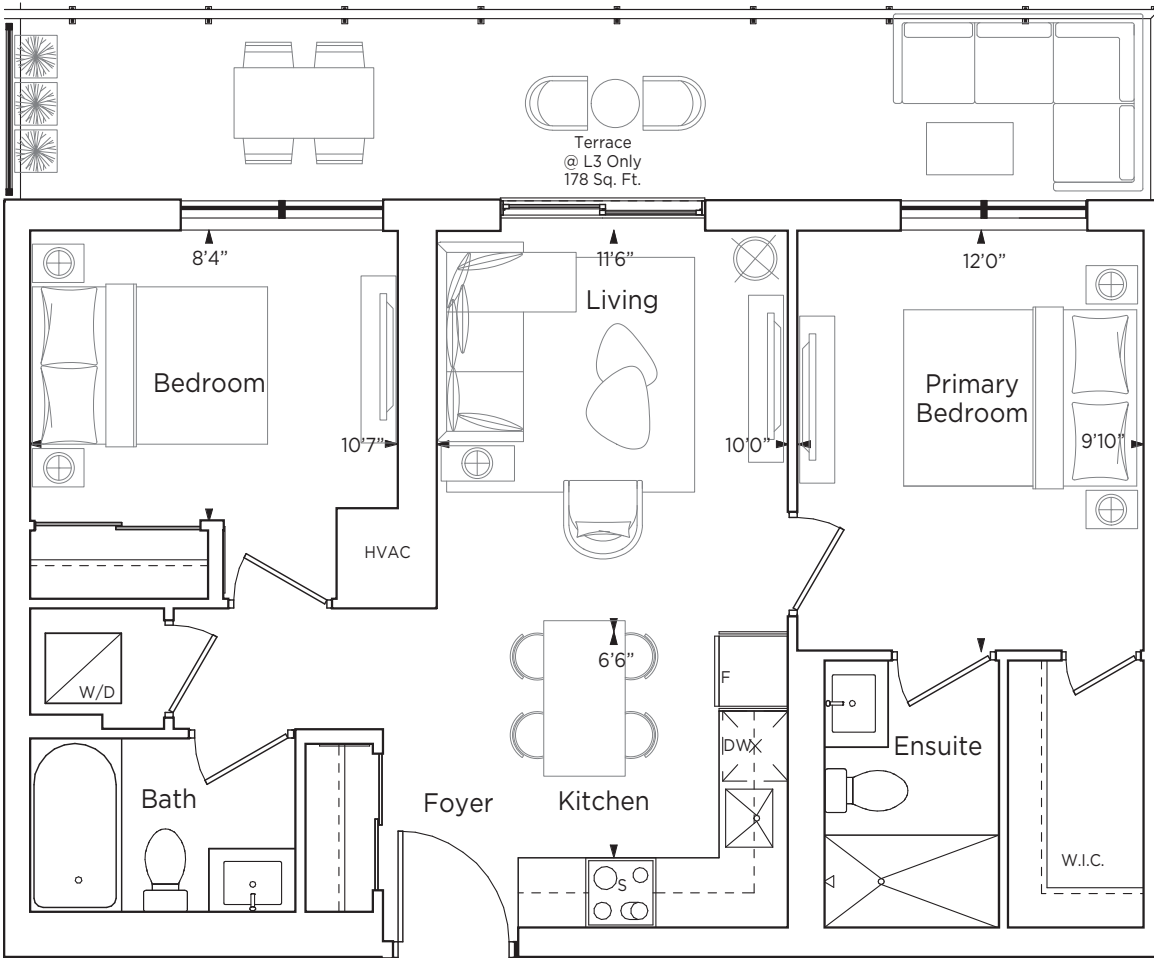

C7

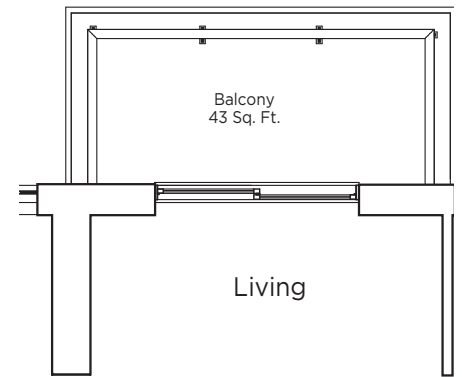

BALCONY PLAN AT LEVEL 4, 5, 6



**Tower A
LEVEL 35-37**



**Tower A
LEVEL 6**



**Tower A
LEVEL 5**



**Tower A
LEVEL 4**



**Tower A
LEVEL 3**



Vincent
CONDOMINIUMS



Materials, specifications and floor plans are subject to change. All renderings are artist's concept. All floor plans are approximate dimensions. Actual usable floor space may vary from stated floor area. Balcony/terrace areas may vary. Windows, room/area dimensions & square feet may vary due to location within building. Furniture not included. E. & O. E.

TWO BED

NASSAU

760 SQ.FT. D6-2 • 356 SQ.FT. TERRACE @ LEVEL 3

744 SQ.FT. D6-1

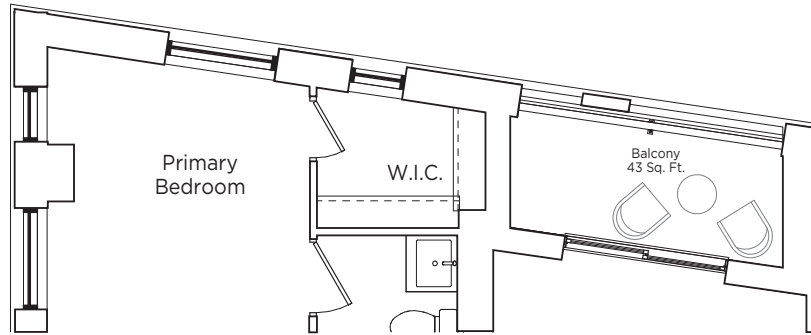

D6-1 BALCONY PLAN AT LEVEL 4, 5

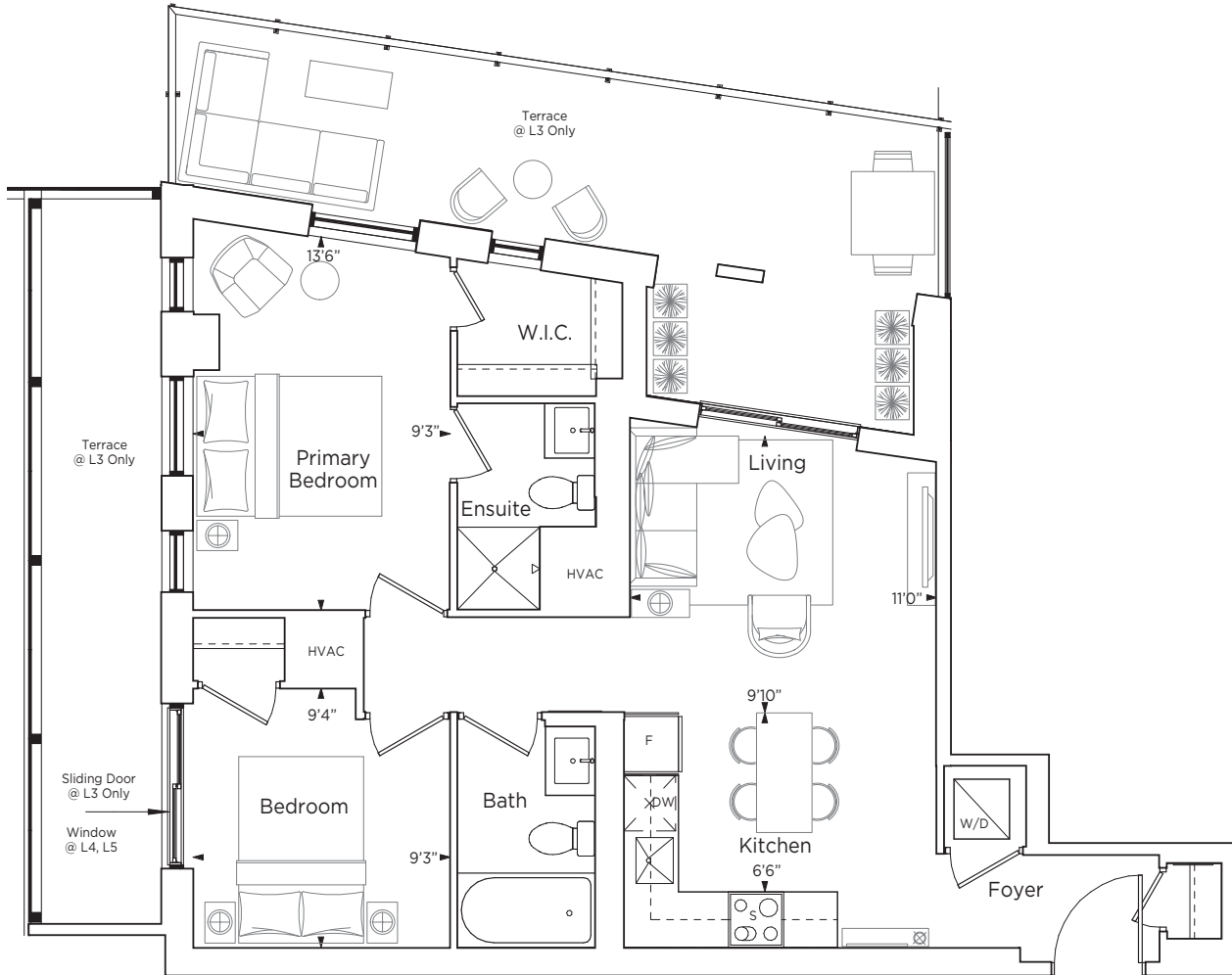

D6-2



Tower A
LEVEL 5

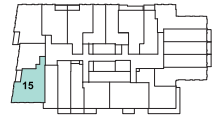

Tower A
LEVEL 4



Tower A
LEVEL 3



Vincent
CONDOMINIUMS



Materials, specifications and floor plans are subject to change. All renderings are artist's concept. All floor plans are approximate dimensions. Actual usable floor space may vary from stated floor area. Balcony/terrace areas may vary. Windows, room/area dimensions & square feet may vary due to location within building. Furniture not included. E. & O. E.

TWO BED

OMEGA

744 SQ.FT. • 177 SQ.FT. BALCONY

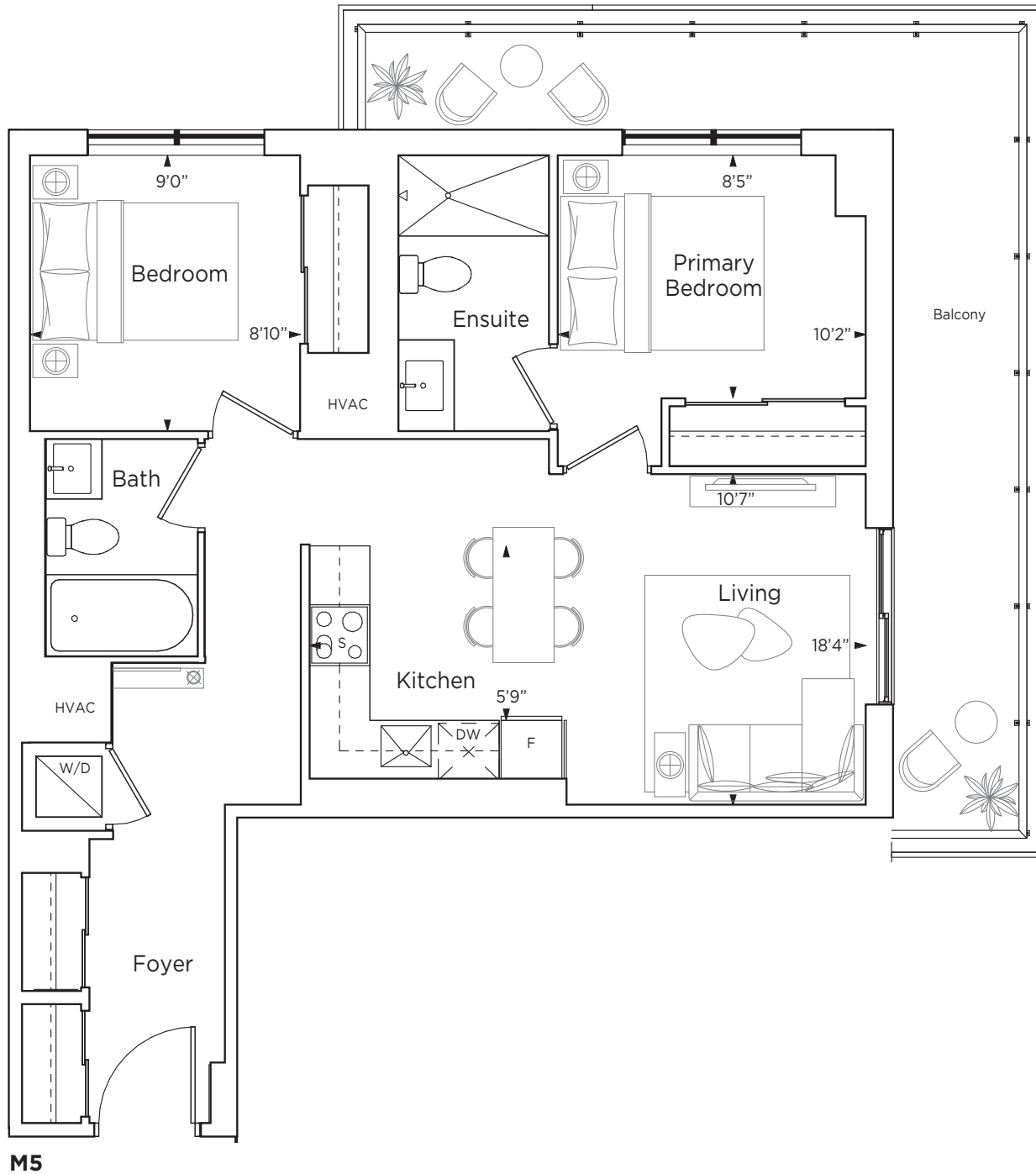

Vincent
CONDOMINIUMS

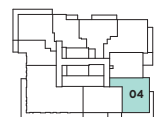

Tower A
LEVEL 35 - 37

Materials, specifications and floor plans are subject to change. All renderings are artist's concept. All floor plans are approximate dimensions. Actual usable floor space may vary from stated floor area. Balcony/terrace areas may vary. Windows, room/area dimensions & square feet may vary due to location within building. Furniture not included. E. & O. E.

TWO BED

OXFORD

746 SQ.FT. • 33 SQ.FT. BALCONY

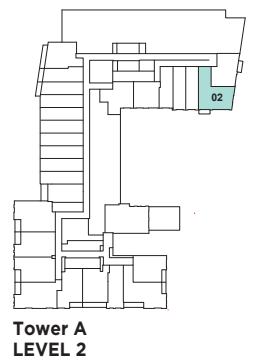
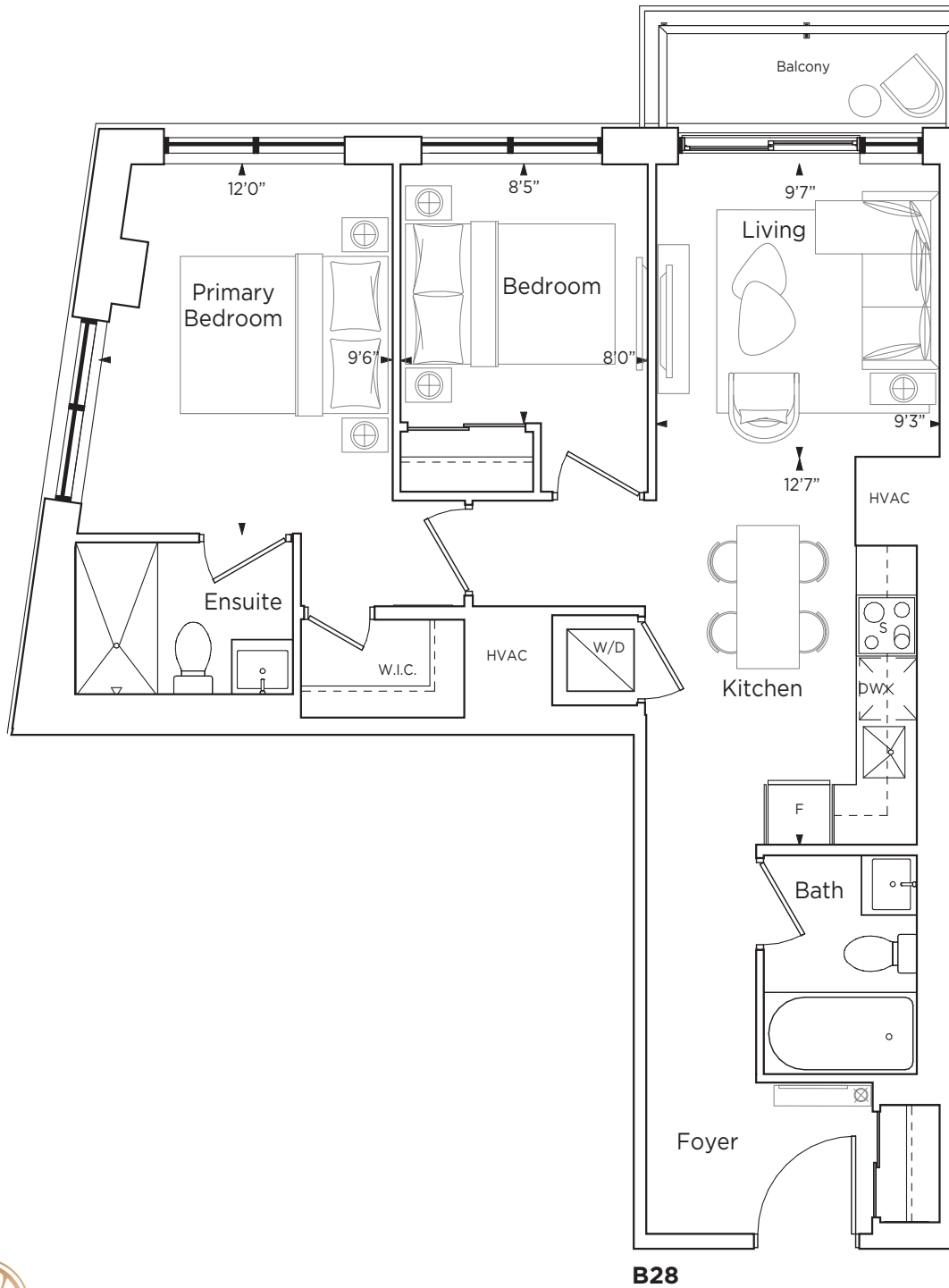

Materials, specifications and floor plans are subject to change. All renderings are artist's concept. All floor plans are approximate dimensions. Actual usable floor space may vary from stated floor area. Balcony/terrace areas may vary. Windows, room/area dimensions & square feet may vary due to location within building. Furniture not included. E. & O. E.

TWO BED (BARRIER-FREE)

QUANTUM

754 SQ.FT. • 33 SQ.FT. BALCONY

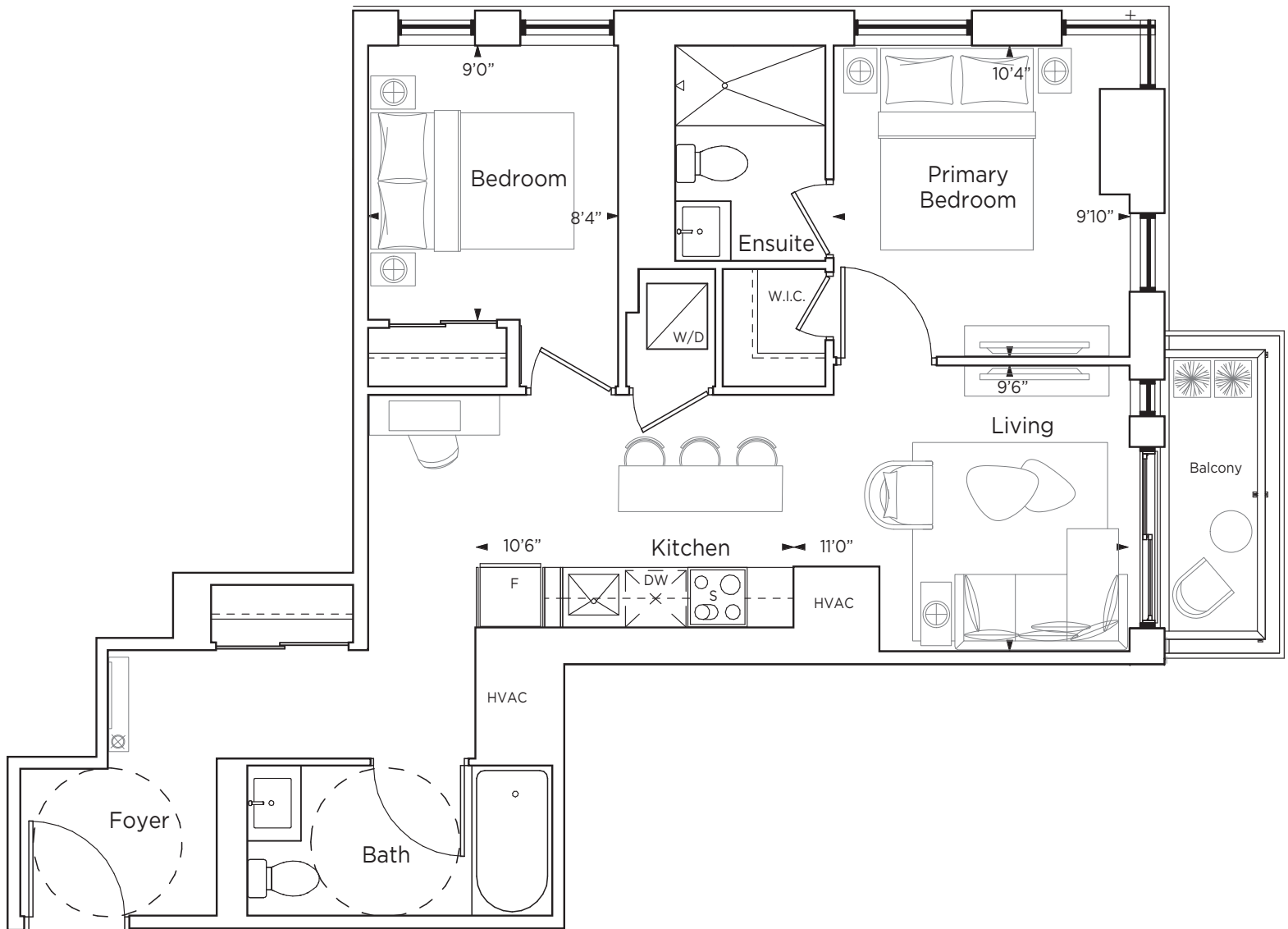

G11

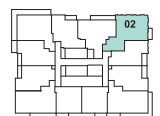

Tower A
LEVEL 15 - 34

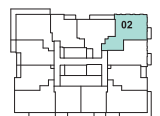

Tower A
LEVEL 7 - 14



Materials, specifications and floor plans are subject to change. All renderings are artist's concept. All floor plans are approximate dimensions. Actual usable floor space may vary from stated floor area. Balcony/terrace areas may vary. Windows, room/area dimensions & square feet may vary due to location within building. Furniture not included. E. & O. E.

TWO BED

RIO DE JANIERO

758 SQ.FT. • 66 SQ.FT. BALCONY

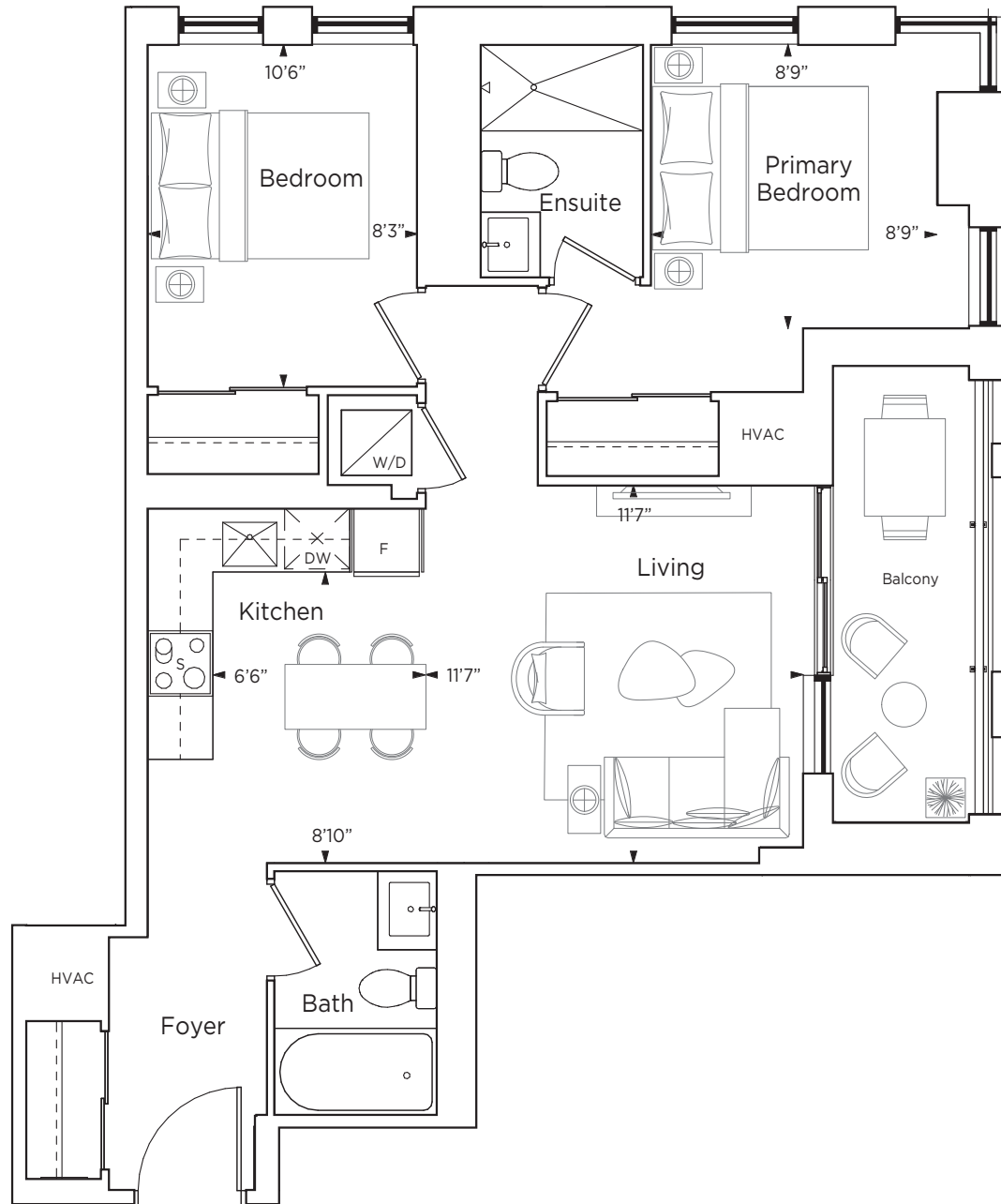

F13



Vincent
CONDOMINIUMS



Tower A
LEVEL 6

Materials, specifications and floor plans are subject to change. All renderings are artist's concept. All floor plans are approximate dimensions. Actual usable floor space may vary from stated floor area. Balcony/terrace areas may vary. Windows, room/area dimensions & square feet may vary due to location within building. Furniture not included. E. & O. E.

TWO BED

SAVILE ROW

802 SQ.FT. • 146 SQ.FT. TERRACE • 33 SQ.FT. BALCONY

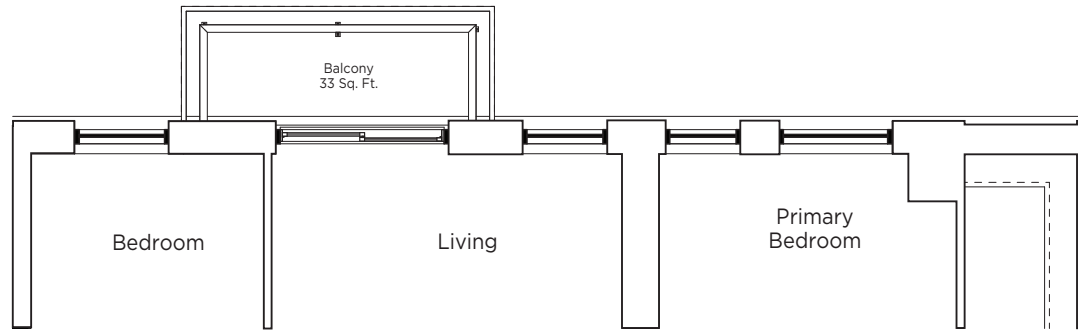

BALCONY PLAN AT LEVEL 6

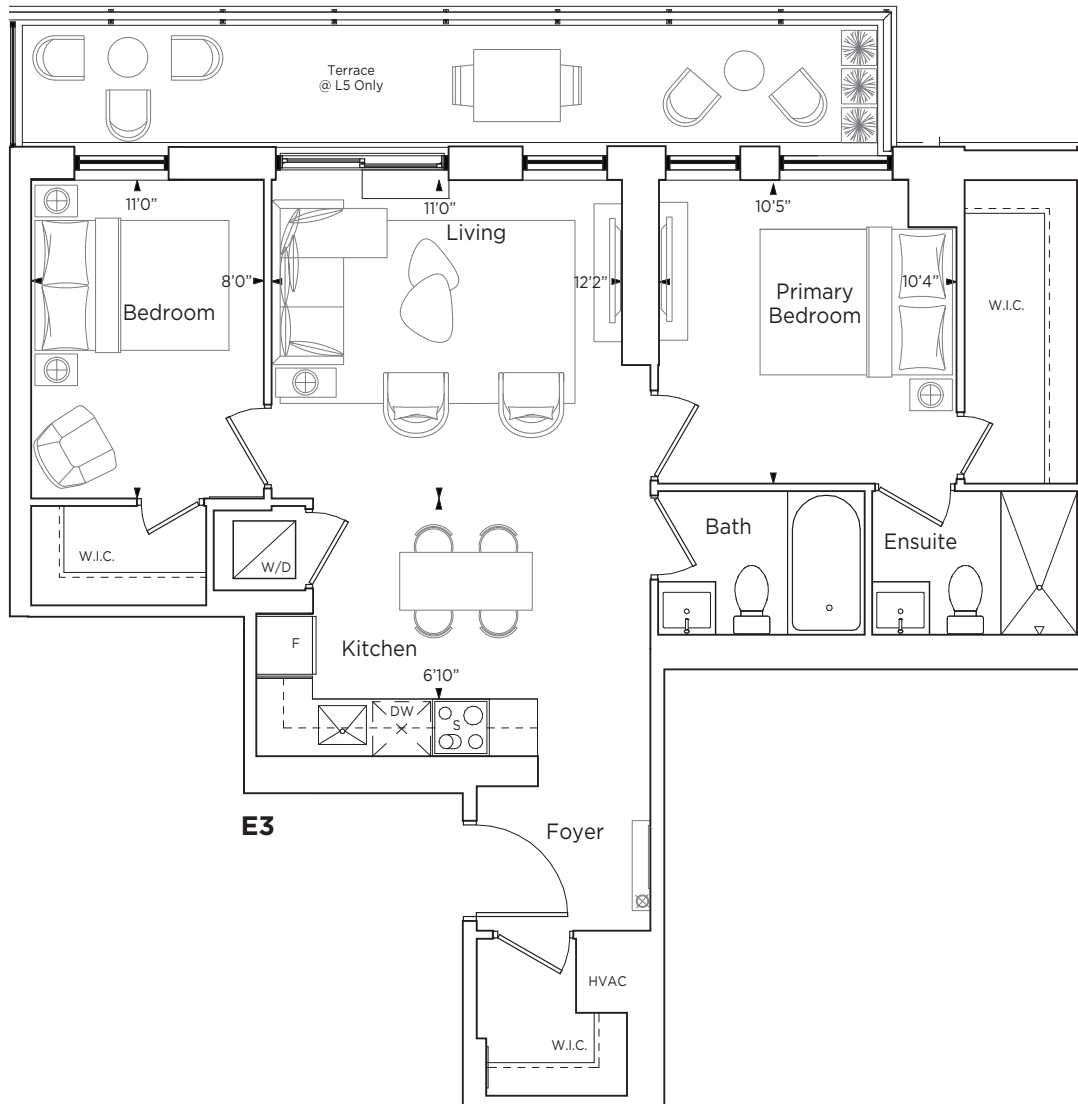

Tower A
LEVEL 6



Tower A
LEVEL 5



Vincent
CONDOMINIUMS



TWO BED

SCOTCH

805 SQ.FT. • 263 SQ.FT. TERRACE

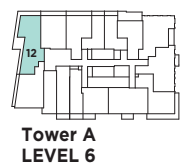
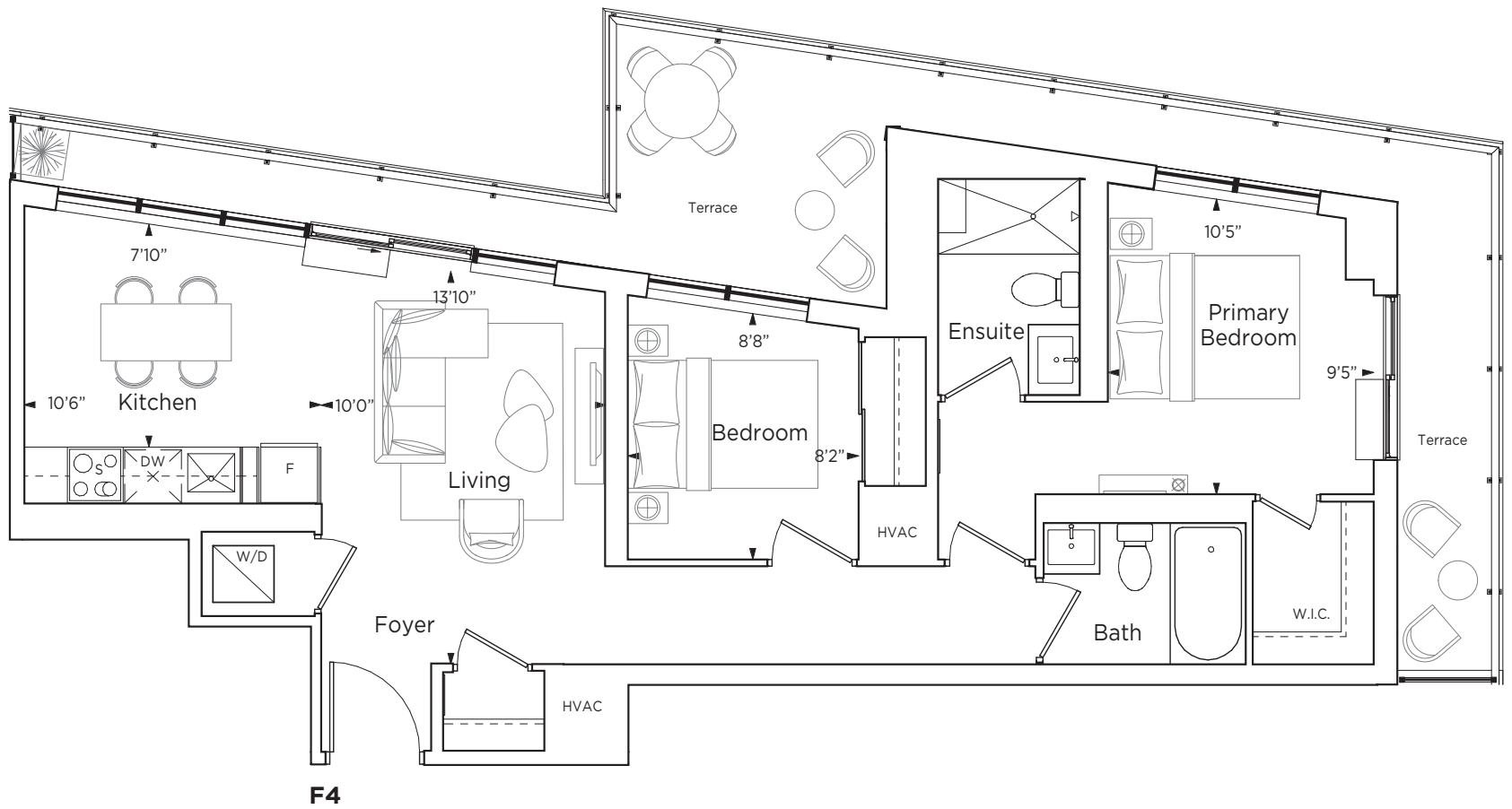

Materials, specifications and floor plans are subject to change. All renderings are artist's concept. All floor plans are approximate dimensions. Actual usable floor space may vary from stated floor area. Balcony/terrace areas may vary. Windows, room/area dimensions & square feet may vary due to location within building. Furniture not included. E. & O. E.

STUDIO

ARGYLE

381 SQ.FT. F1-1 • 40 SQ.FT. TERRACE
391 SQ.FT. F1-2 • 42 SQ.FT. TERRACE

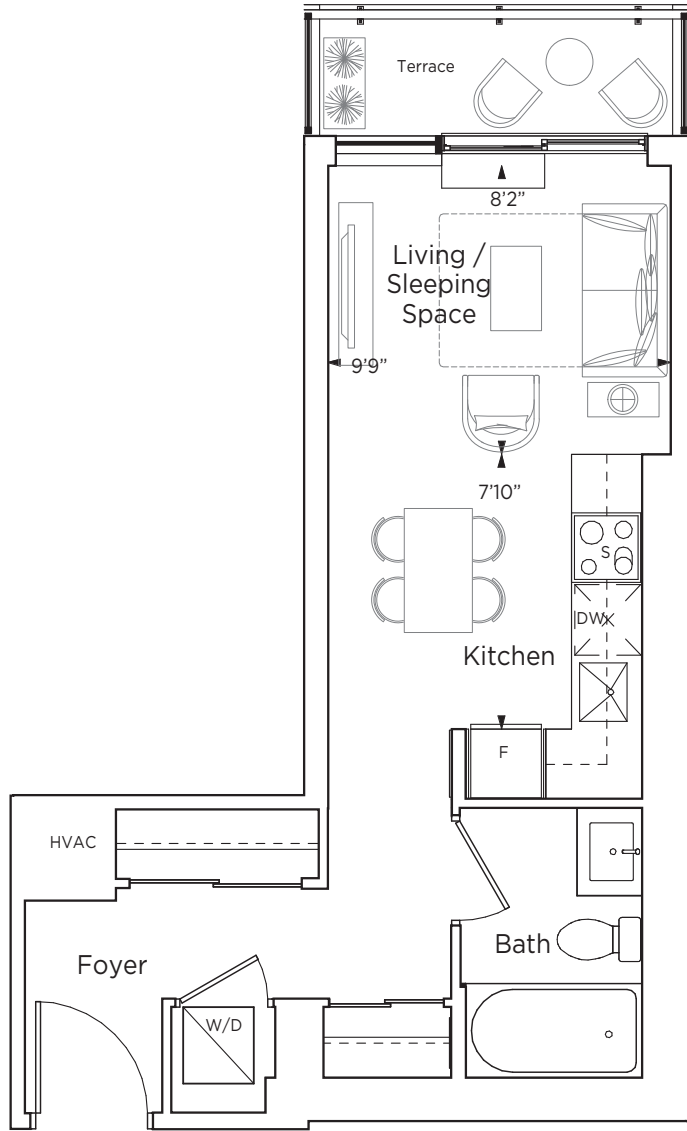

F1-1

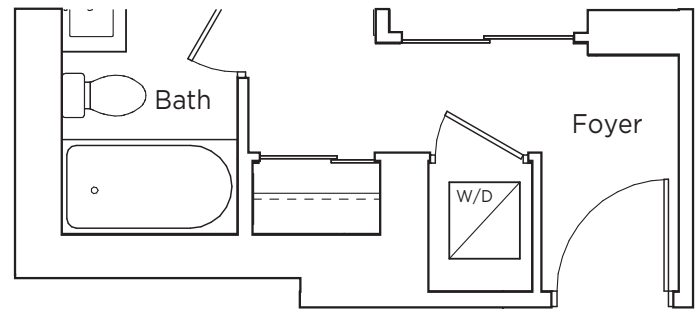

F1-2



Vincent
CONDOMINIUMS

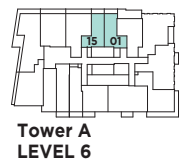

Materials, specifications and floor plans are subject to change. All renderings are artist's concept. All floor plans are approximate dimensions. Actual usable floor space may vary from stated floor area. Balcony/terrace areas may vary. Windows, room/area dimensions & square feet may vary due to location within building. Furniture not included. E. & O. E.

STUDIO

ASTON

388 SQ.FT. B4, B4-1 TO B4-5 • 401 SQ.FT. B4-6 • 377 SQ.FT. B4-7

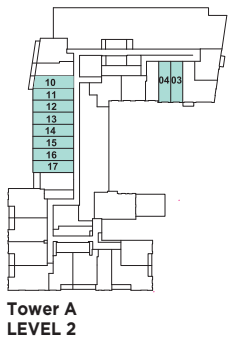
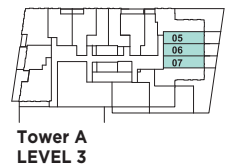
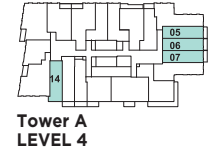
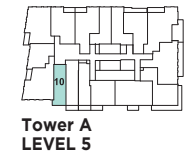
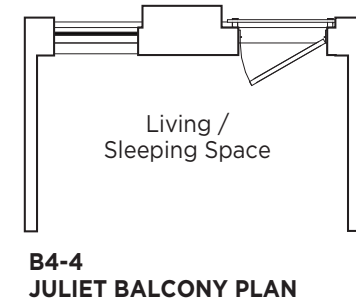
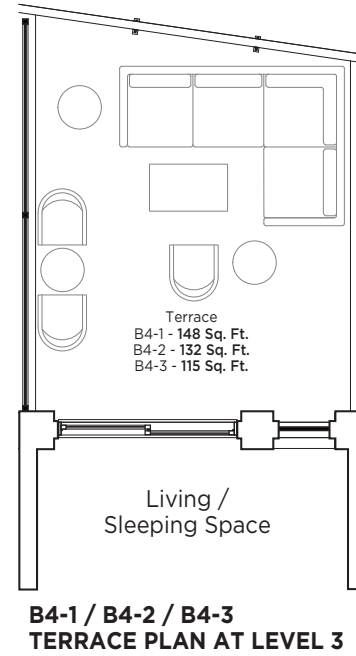
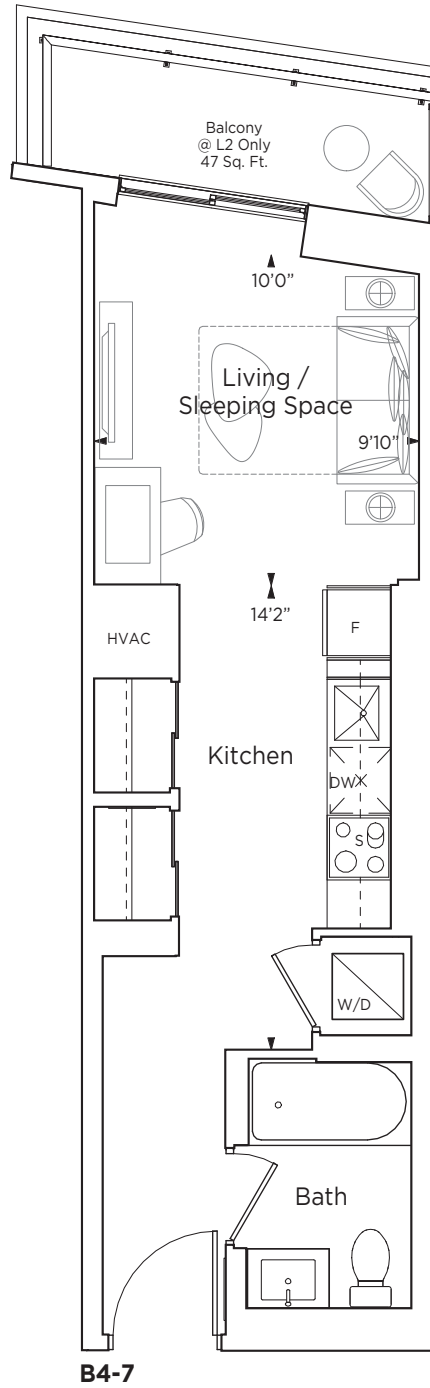
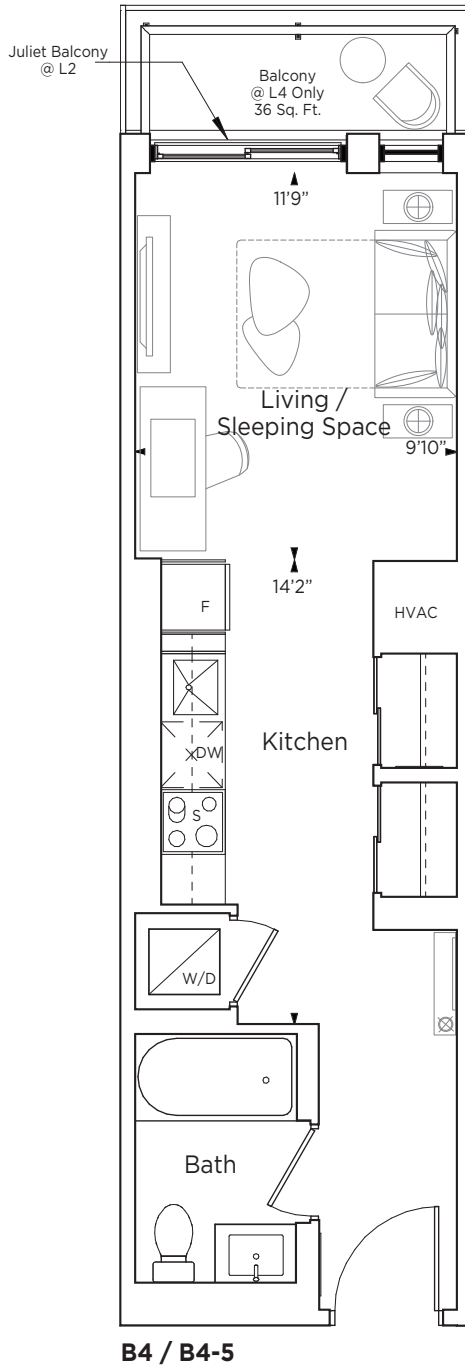

Vincent
CONDOMINIUMS



Materials, specifications and floor plans are subject to change. All renderings are artist's concept. All floor plans are approximate dimensions. Actual usable floor space may vary from stated floor area. Balcony/terrace areas may vary. Windows, room/area dimensions & square feet may vary due to location within building. Furniture not included. E. & O. E.

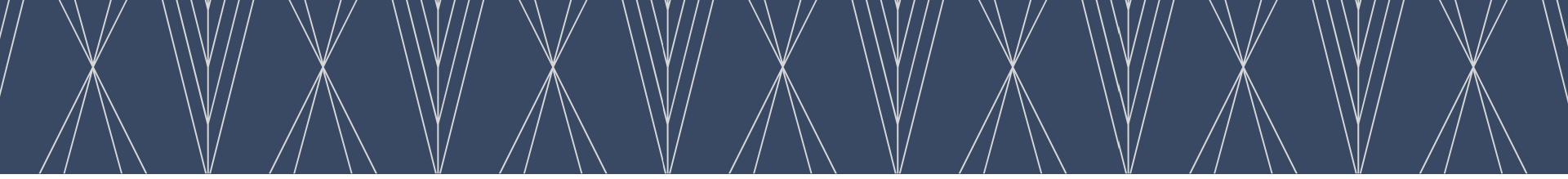

STUDIO
BACCARAT
 390 SQ.FT.

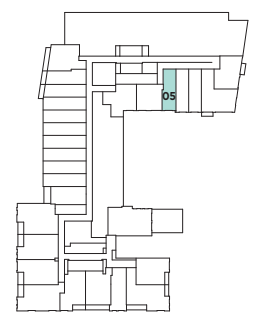
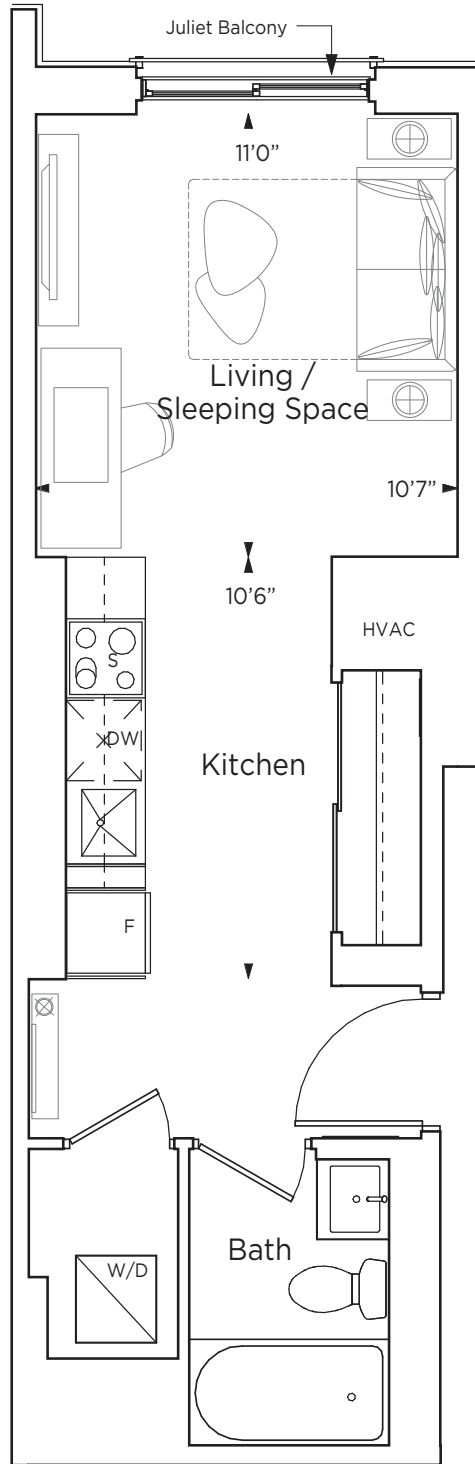

Tower A
 LEVEL 2

Materials, specifications and floor plans are subject to change. All renderings are artist's concept. All floor plans are approximate dimensions. Actual usable floor space may vary from stated floor area. Balcony/terrace areas may vary. Windows, room/area dimensions & square feet may vary due to location within building. Furniture not included. E. & O. E.

STUDIO

BAJA

396 SQ.FT. • 49 SQ.FT. BALCONY

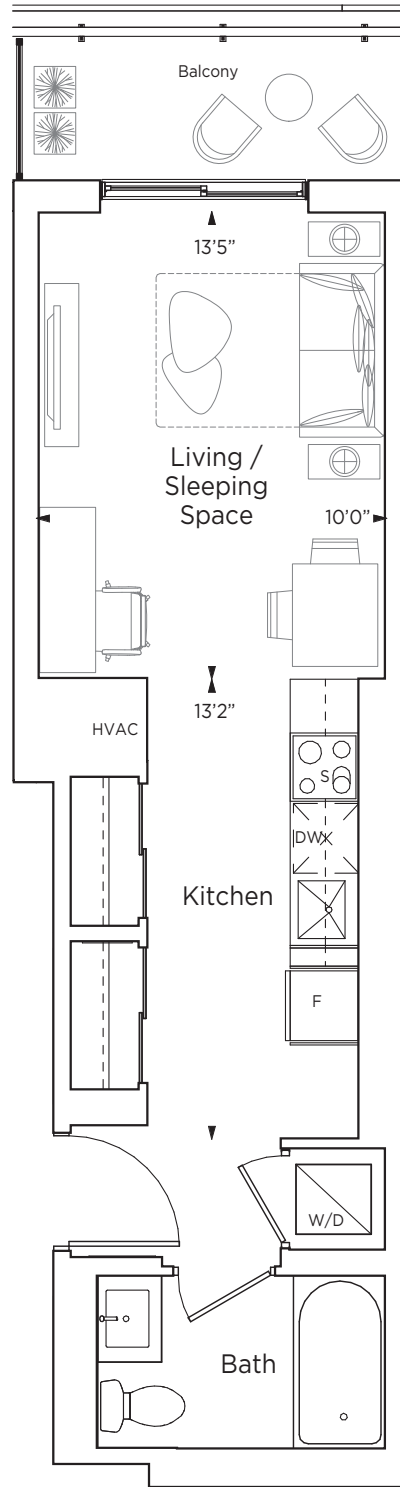

D9



Tower A
LEVEL 6



Tower A
LEVEL 5

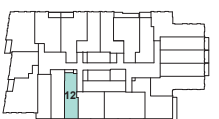

Tower A
LEVEL 4



Vincent
CONDOMINIUMS



STUDIO

BANGKOK

400 SQ.FT. • 45 SQ.FT. BALCONY

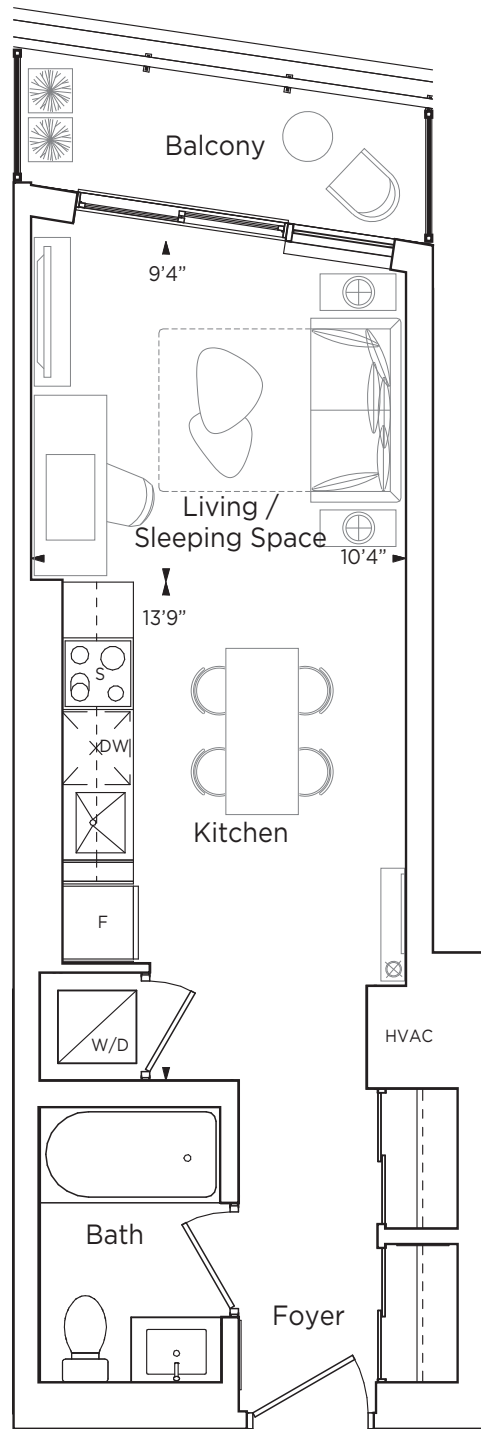

B2

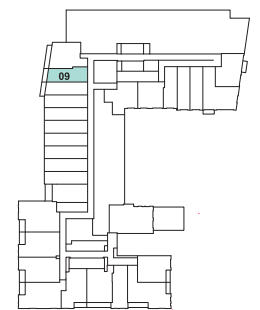

Tower A
LEVEL 2



Vincent
CONDOMINIUMS



Materials, specifications and floor plans are subject to change. All renderings are artist's concept. All floor plans are approximate dimensions. Actual usable floor space may vary from stated floor area. Balcony/terrace areas may vary. Windows, room/area dimensions & square feet may vary due to location within building. Furniture not included. E. & O. E.

ONE BED

BARCHETTA

432 SQ.FT. • 129 SQ.FT. TERRACE

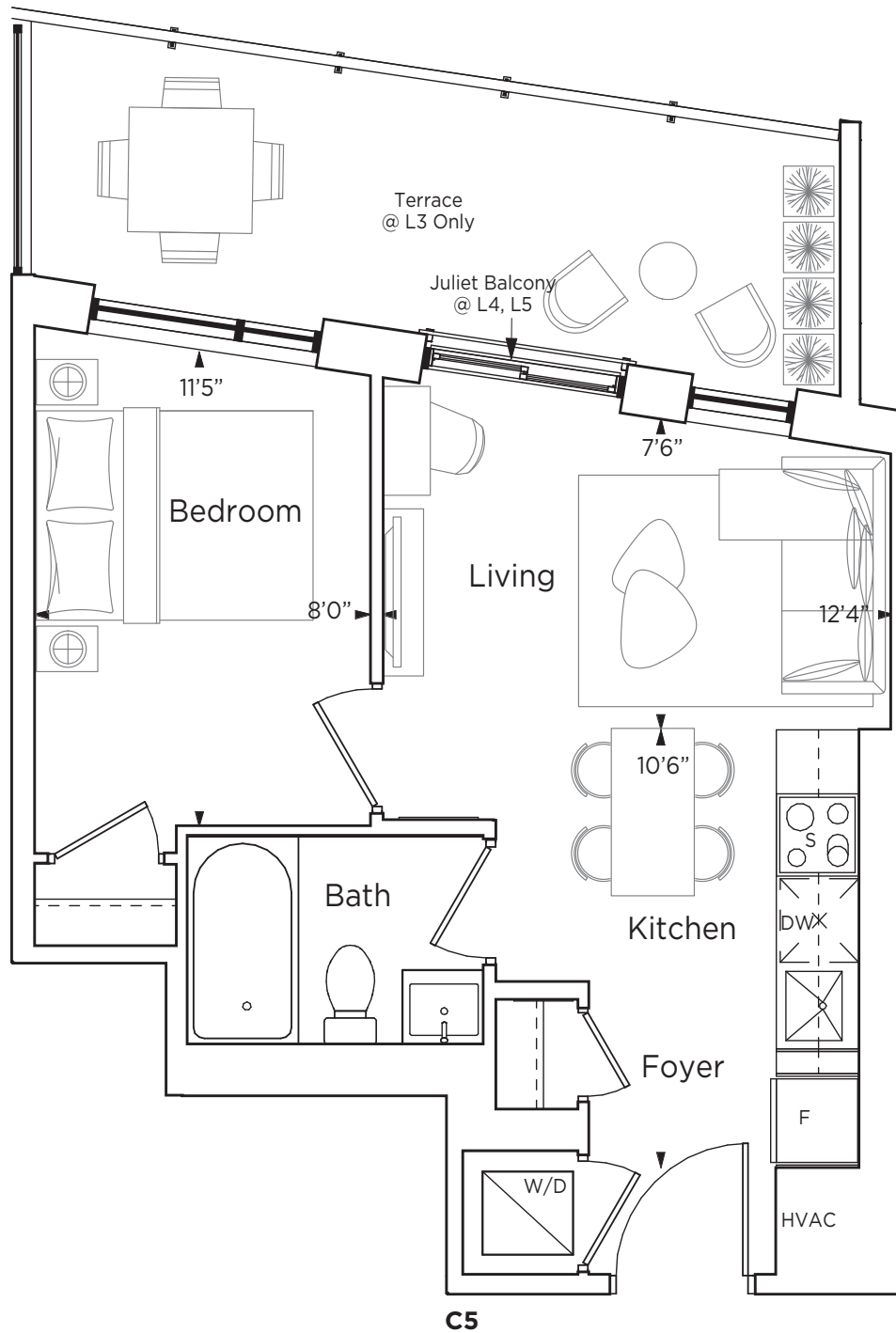

Tower A
LEVEL 5



Tower A
LEVEL 4



Tower A
LEVEL 3



Vincent
CONDOMINIUMS



STUDIO (BARRIER-FREE)

BELGRADE

433 SQ.FT. C1-1 • 443 SQ.FT. C1-2

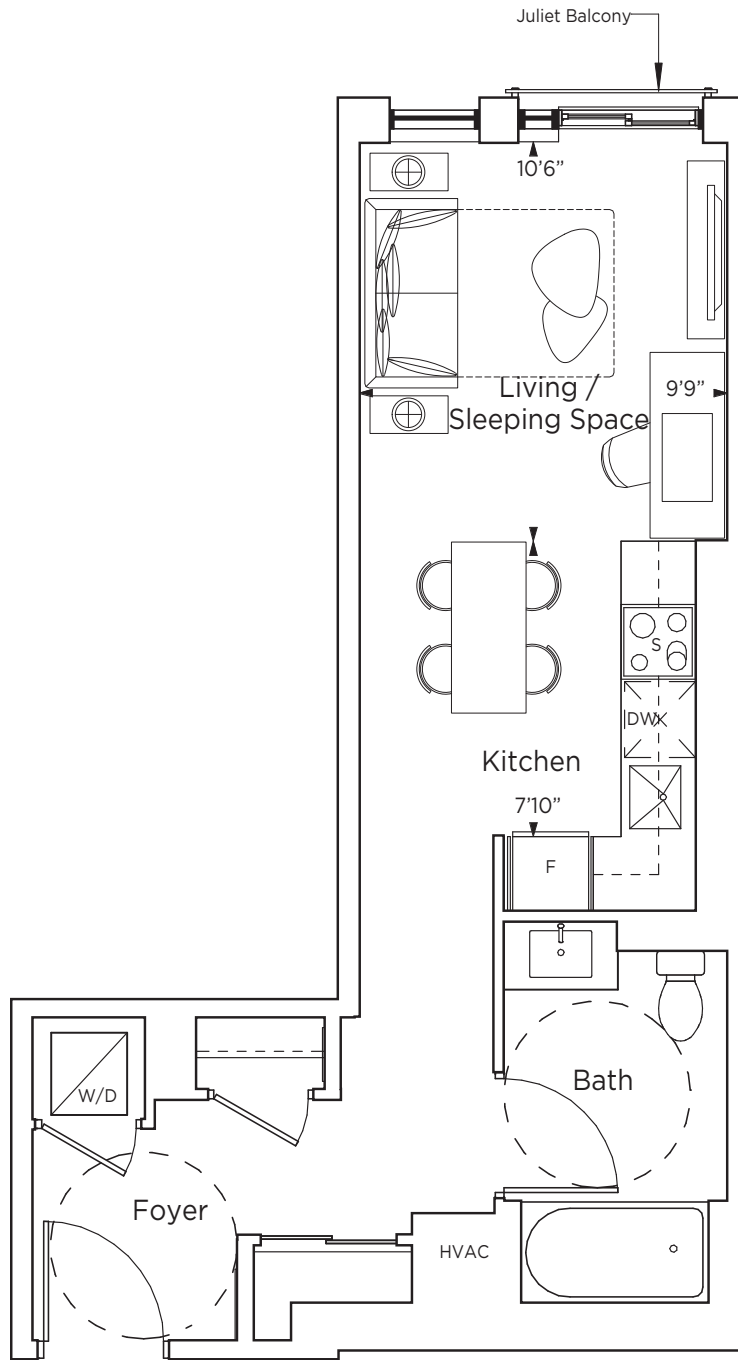

C1 - 1

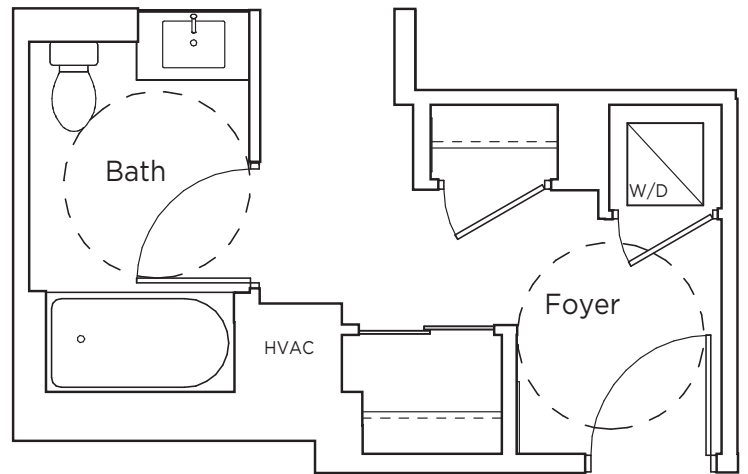

C1 - 2

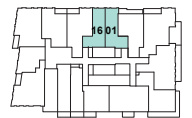

Tower A
LEVEL 5



Tower A
LEVEL 4

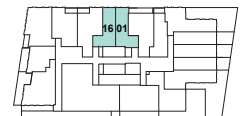

Tower A
LEVEL 3



Vincent
CONDOMINIUMS



STUDIO

BERLIN

440 SQ.FT. • 39 SQ.FT. BALCONY

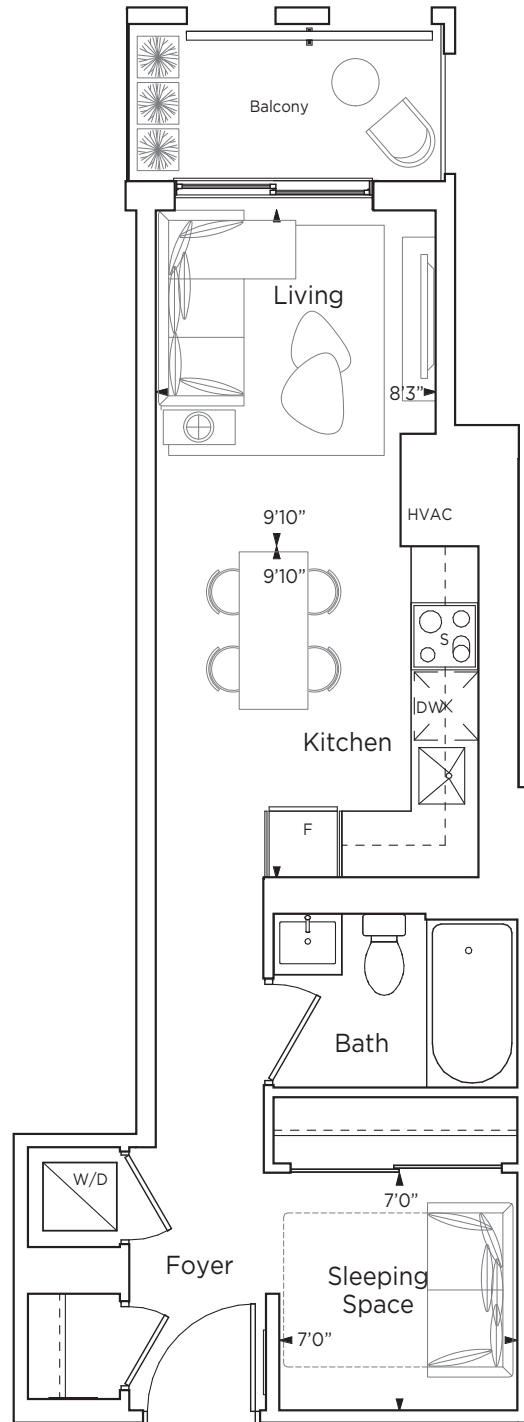

C14



Tower A
LEVEL 4



Tower A
LEVEL 3



Vincent
CONDOMINIUMS





STUDIO

BLACK TIE

441 SQ.FT. • 48 SQ.FT. BALCONY

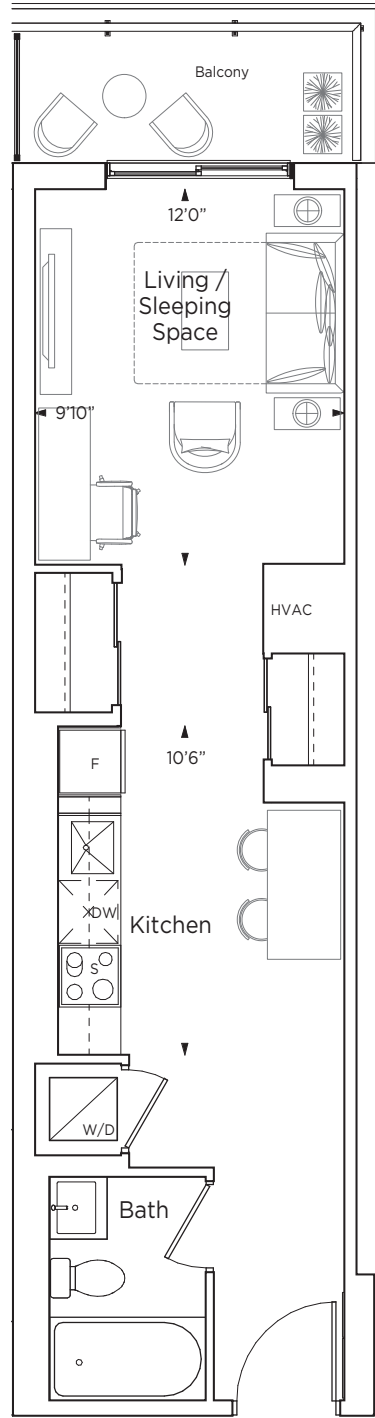

D8



Tower A
LEVEL 6



Tower A
LEVEL 5

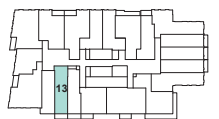

Tower A
LEVEL 4



Vincent
CONDOMINIUMS



Materials, specifications and floor plans are subject to change. All renderings are artist's concept. All floor plans are approximate dimensions. Actual usable floor space may vary from stated floor area. Balcony/terrace areas may vary. Windows, room/area dimensions & square feet may vary due to location within building. Furniture not included. E. & O. E.

ONE BED

CARTE BLANCHE

479 SQ.FT. • 43 SQ.FT. BALCONY

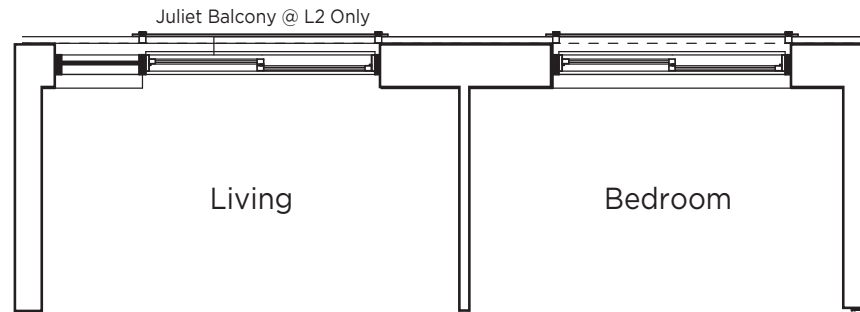

PLAN AT LEVEL 2 - 472 Sq. Ft.

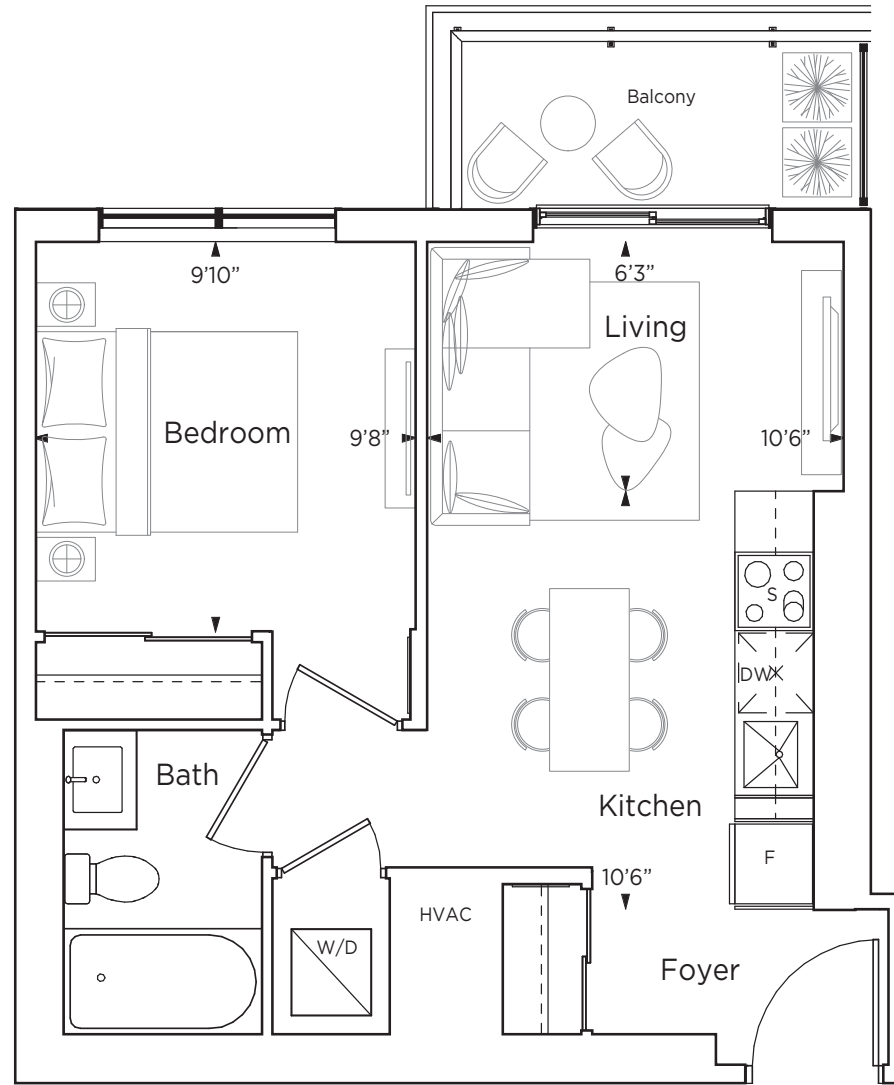

G6

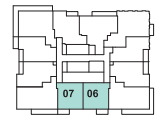

Tower A
LEVEL 15-34



Tower A
LEVEL 7 - 14



Tower A
LEVEL 6



Tower A
LEVEL 5



Tower A
LEVEL 4

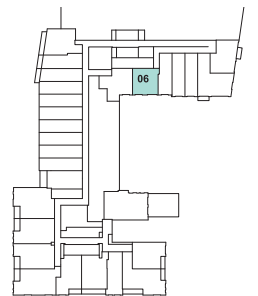

Tower A
LEVEL 2



Vincent
CONDOMINIUMS



ONE BED

CAVIAR

514 SQ.FT. • 152 SQ.FT. TERRACE

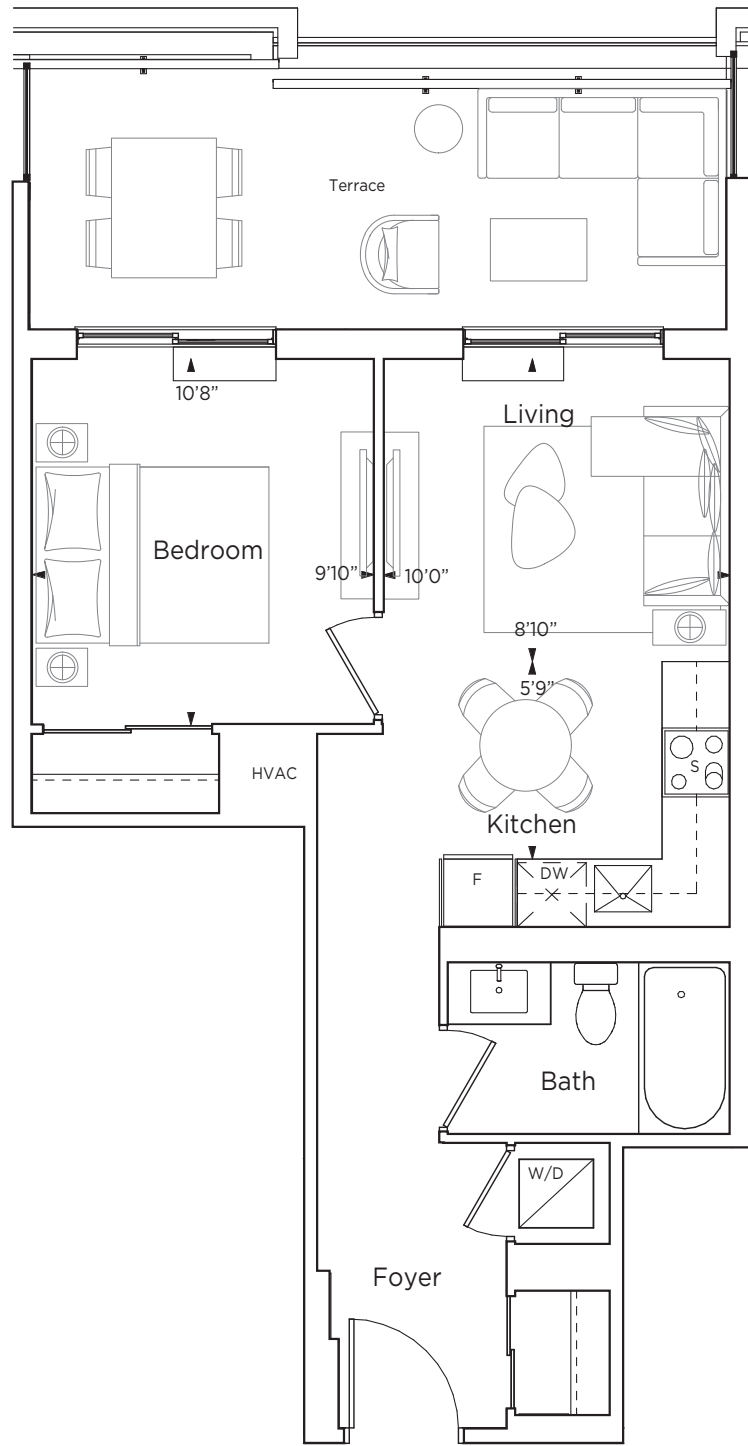

F14



Vincent
CONDOMINIUMS



Tower A
LEVEL 6

Materials, specifications and floor plans are subject to change. All renderings are artist's concept. All floor plans are approximate dimensions. Actual usable floor space may vary from stated floor area. Balcony/terrace areas may vary. Windows, room/area dimensions & square feet may vary due to location within building. Furniture not included. E. & O. E.

ONE BED (BARRIER-FREE)

CHAMPAGNE

518 SQ.FT. • 45 SQ.FT. BALCONY

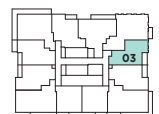
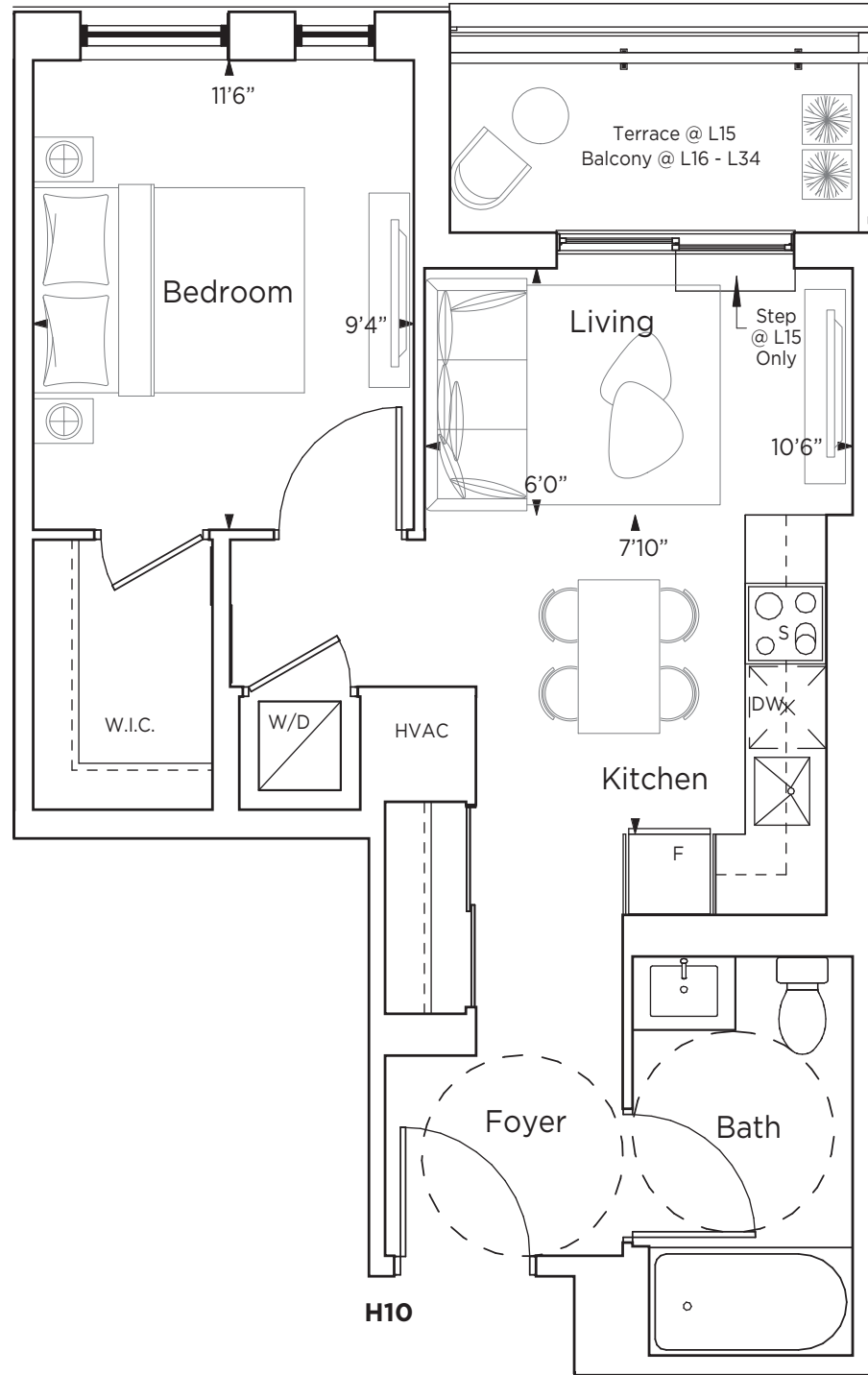

Tower A
LEVEL 15-34

ONE BED

COGNAC

528 SQ.FT. • 44 SQ.FT. BALCONY

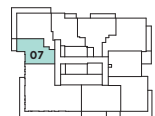
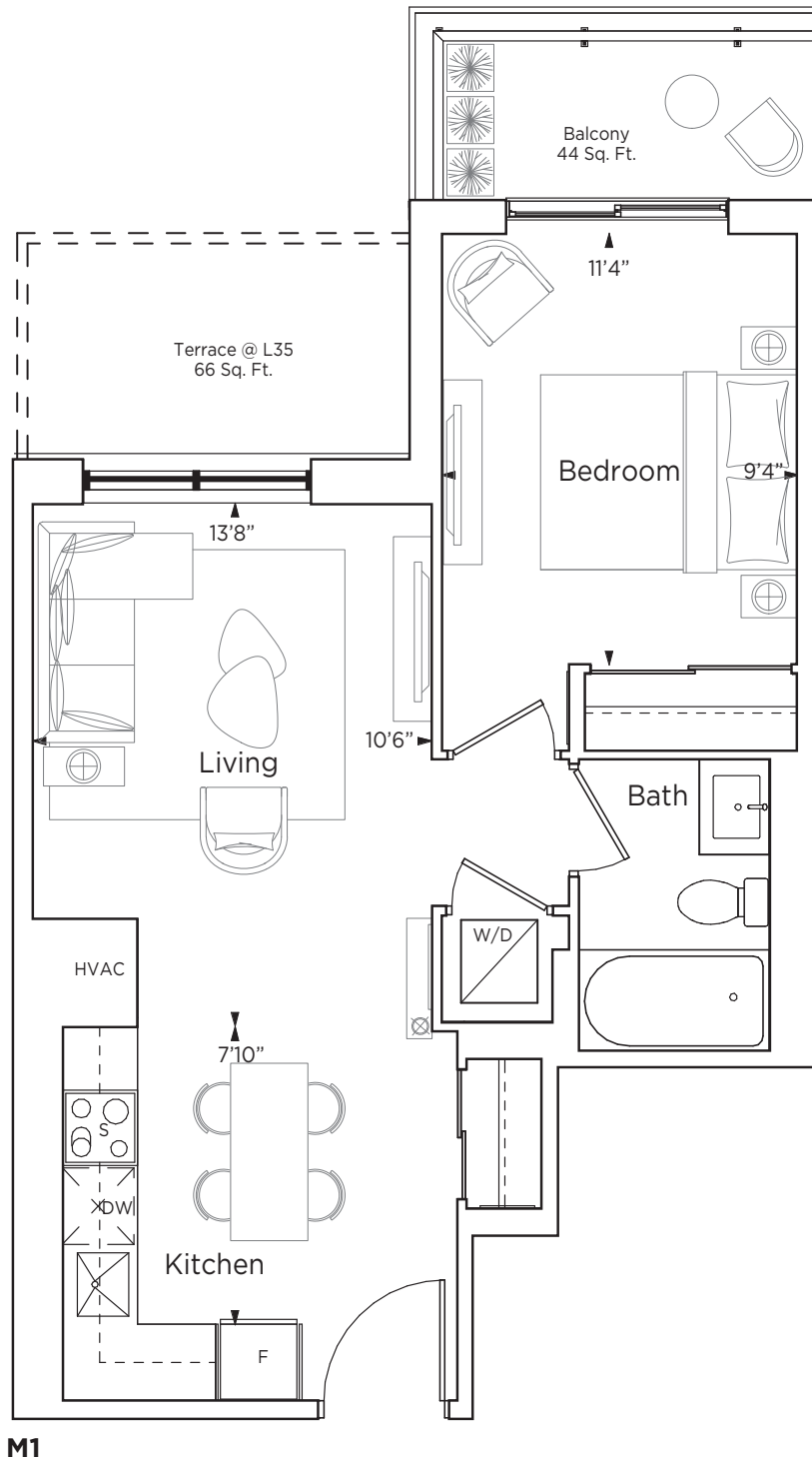

Tower A
LEVEL 36 - 37

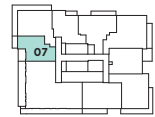

Tower A
LEVEL 35



Vincent
CONDOMINIUMS



Materials, specifications and floor plans are subject to change. All renderings are artist's concept. All floor plans are approximate dimensions. Actual usable floor space may vary from stated floor area. Balcony/terrace areas may vary. Windows, room/area dimensions & square feet may vary due to location within building. Furniture not included. E. & O. E.

ONE BED + DEN

DELACROIX

557 SQ.FT. • 35 SQ.FT. BALCONY



B29

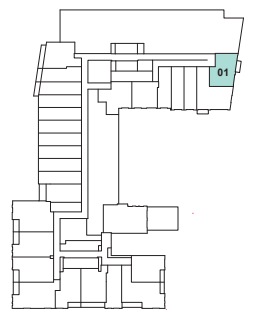

Tower A
LEVEL 2



Materials, specifications and floor plans are subject to change. All renderings are artist's concept. All floor plans are approximate dimensions. Actual usable floor space may vary from stated floor area. Balcony/terrace areas may vary. Windows, room/area dimensions & square feet may vary due to location within building. Furniture not included. E. & O. E.

ONE BED + DEN

DIAMOND

557 SQ.FT. • 647 SQ.FT. TERRACE

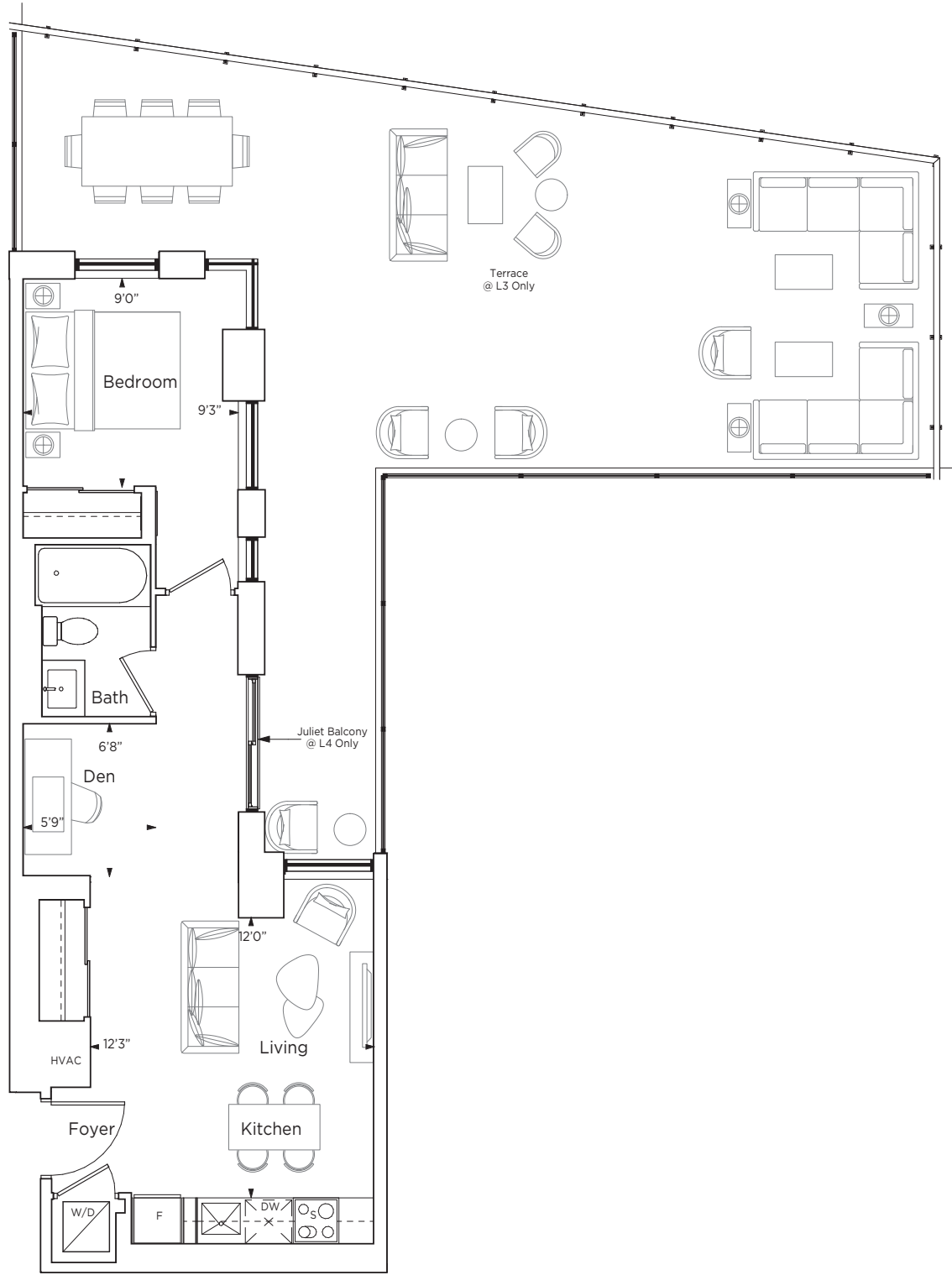

C9



Tower A
LEVEL 4



Tower A
LEVEL 3



Vincent
CONDOMINIUMS



Materials, specifications and floor plans are subject to change. All renderings are artist's concept. All floor plans are approximate dimensions. Actual usable floor space may vary from stated floor area. Balcony/terrace areas may vary. Windows, room/area dimensions & square feet may vary due to location within building. Furniture not included. E. & O. E.

ONE BED + DEN

DOLOMITES

561 SQ.FT.

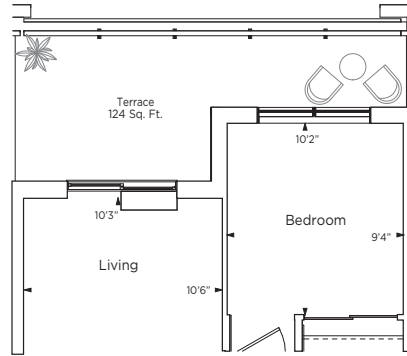
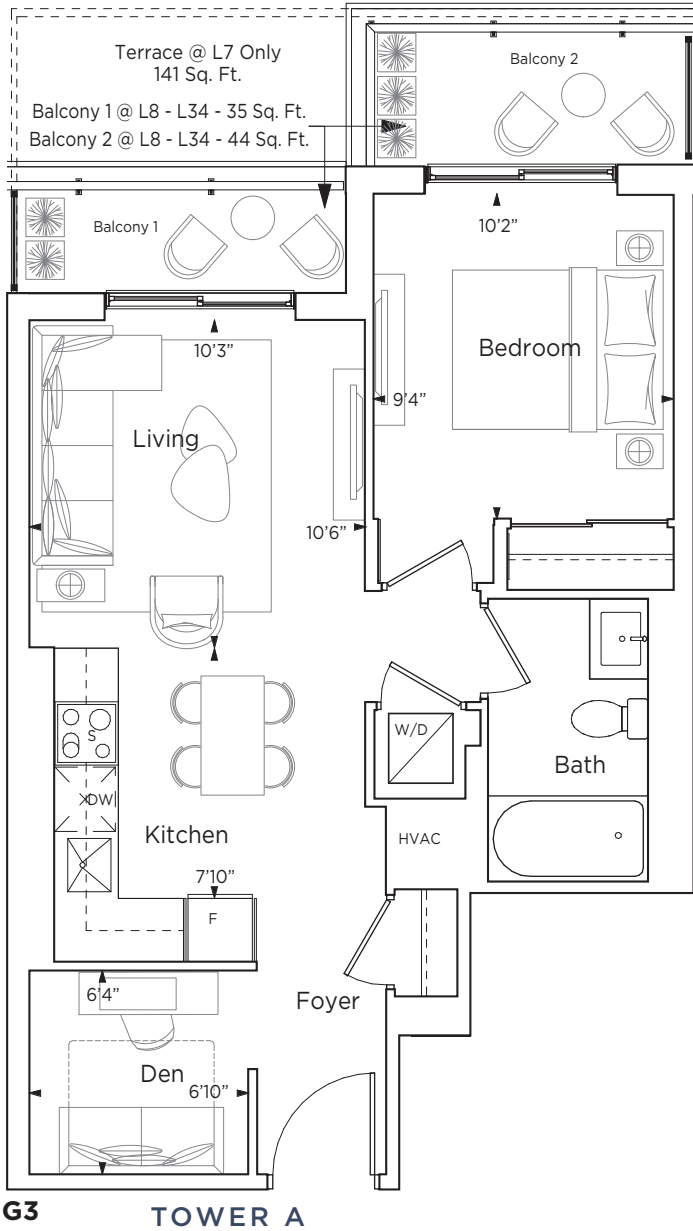

TERRACE PLAN AT LEVEL 9

TOWER B

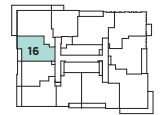
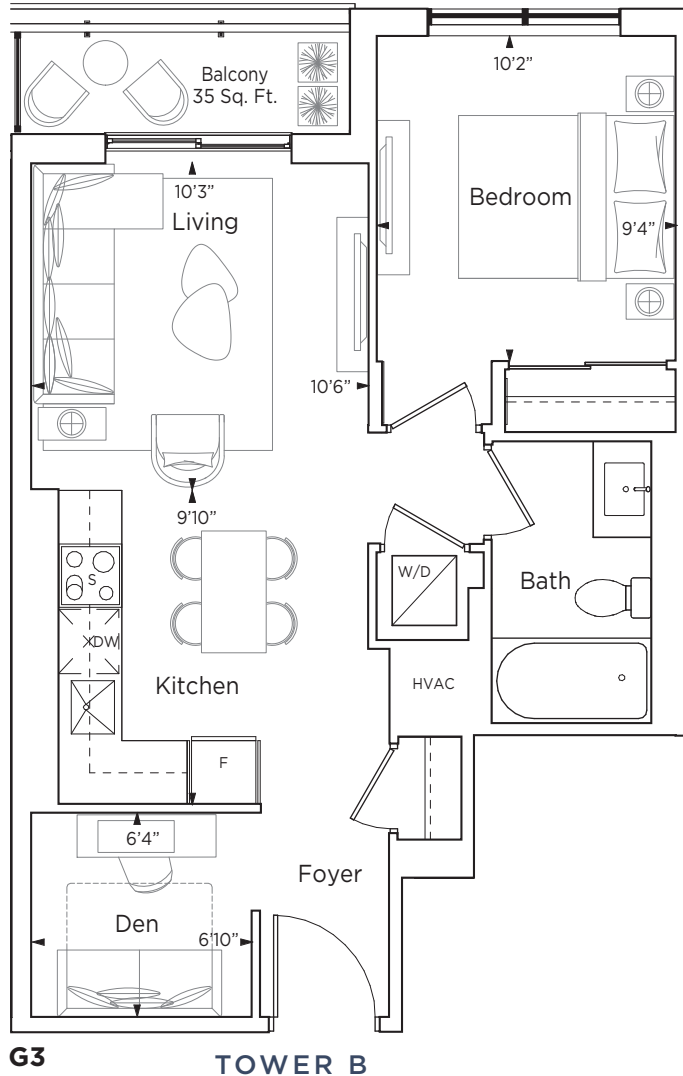

Tower B
LEVEL 25 - 27

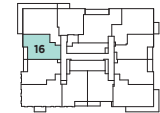

Tower B
LEVEL 15 - 24

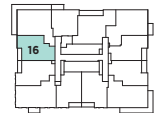

Tower B
LEVEL 10 - 14

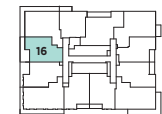

Tower B
LEVEL 9

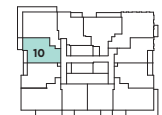

Tower A
LEVEL 15-34

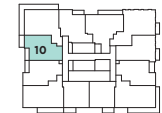

Tower A
LEVEL 8-14



Tower A
LEVEL 7



Vincent
CONDOMINIUMS



ONE BED + DEN

ESPRIT

568 SQ.FT. • 36 SQ.FT. BALCONY @ LEVEL 8-37

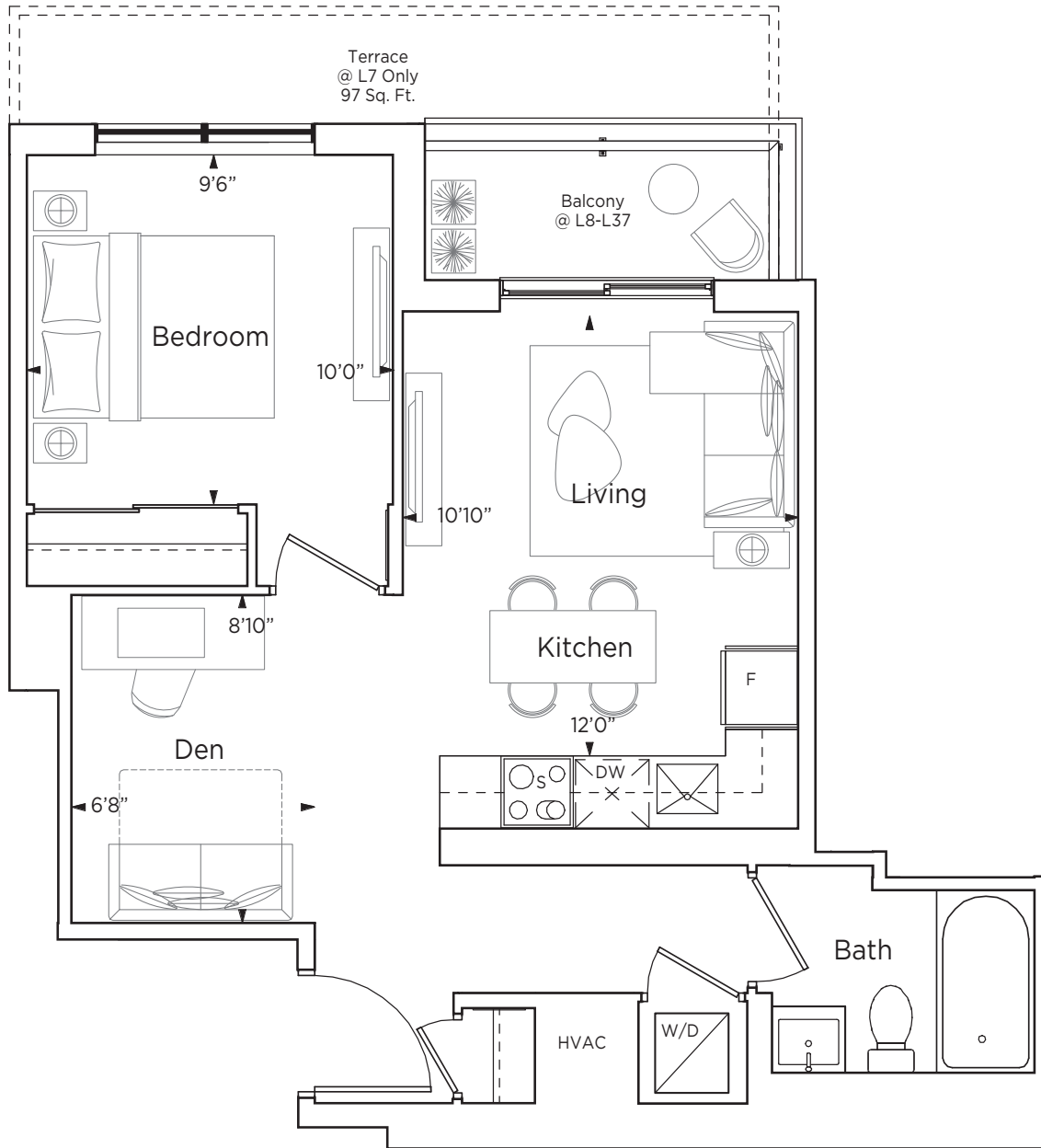

Tower A
LEVEL 35-37



Tower A
LEVEL 8-34



Tower A
LEVEL 7



Materials, specifications and floor plans are subject to change. All renderings are artist's concept. All floor plans are approximate dimensions. Actual usable floor space may vary from stated floor area. Balcony/terrace areas may vary. Windows, room/area dimensions & square feet may vary due to location within building. Furniture not included. E. & O. E.

ONE BED + DEN

FARO

571 SQ.FT. • 90 SQ.FT. TERRACE

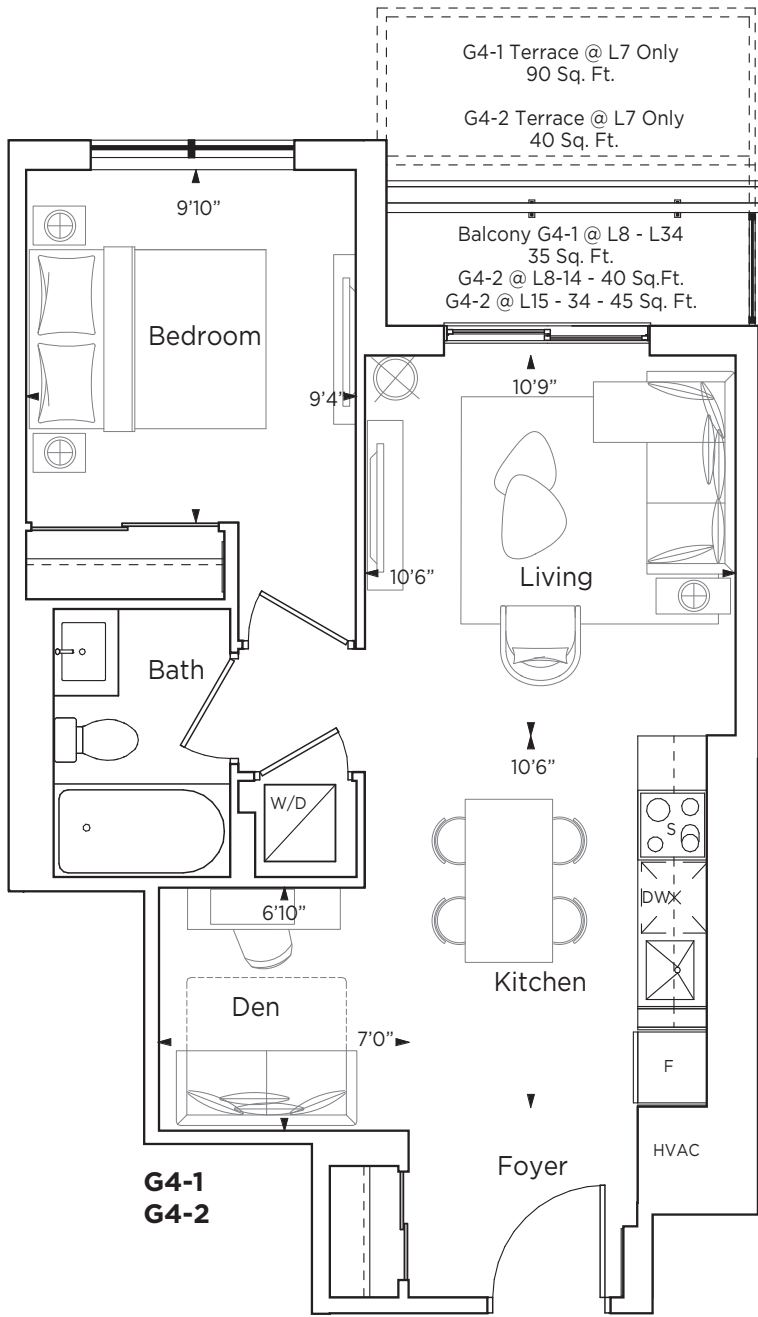

TOWER A

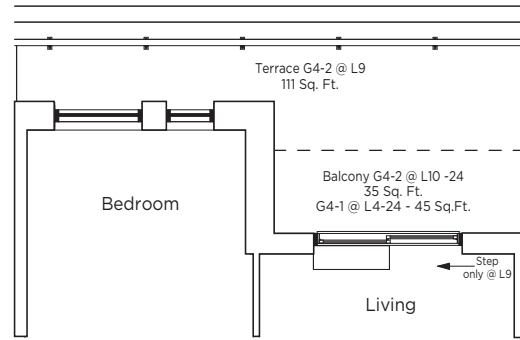

TERRACE PLAN SUITE G4-2 AT LEVEL 9

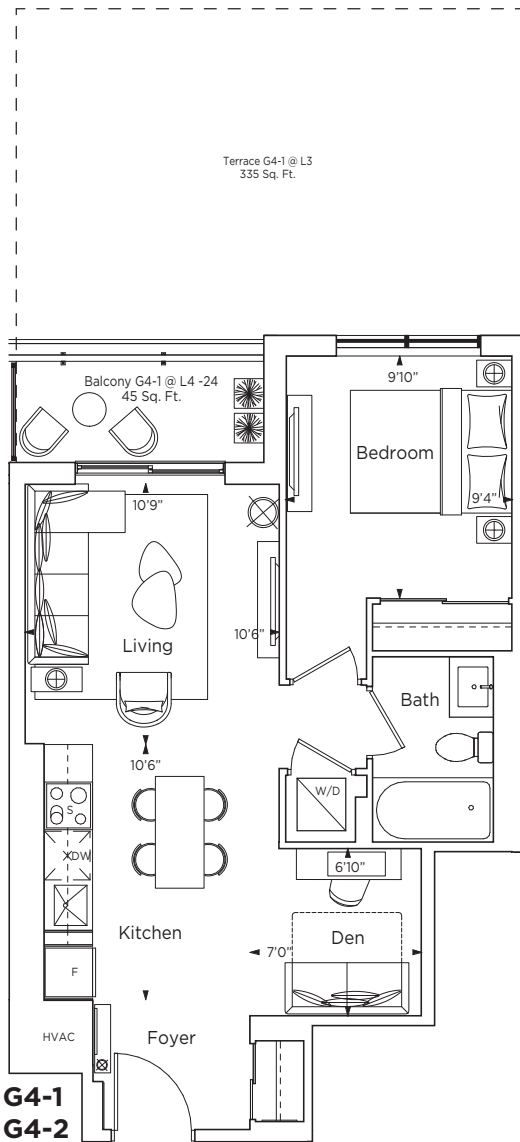

TOWER B



Tower B LEVEL 15 - 24

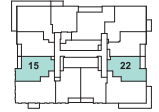

Tower B LEVEL 10 - 14



Tower B LEVEL 9

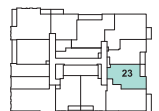

Tower B LEVEL 7 - 8

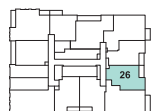

Tower B LEVEL 6

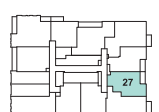

Tower B LEVEL 5

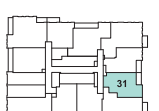

Tower B LEVEL 4

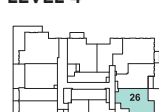

Tower B LEVEL 3

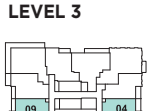

Tower A LEVEL 15-34

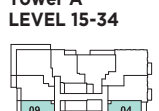

Tower A LEVEL 8-14

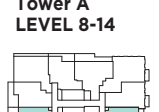

Tower A LEVEL 7



Vincent
CONDOMINIUMS



Materials, specifications and floor plans are subject to change. All renderings are artist's concept. All floor plans are approximate dimensions. Actual usable floor space may vary from stated floor area. Balcony/terrace areas may vary. Windows, room/area dimensions & square feet may vary due to location within building. Furniture not included. E. & O. E.

ONE BED + DEN

FEDORA

595 SQ.FT. • 80 SQ.FT. TERRACE - TOWER A
577 SQ.FT. • 80 SQ.FT. BALCONY • 200 SQ.FT. TERRACE - TOWER B

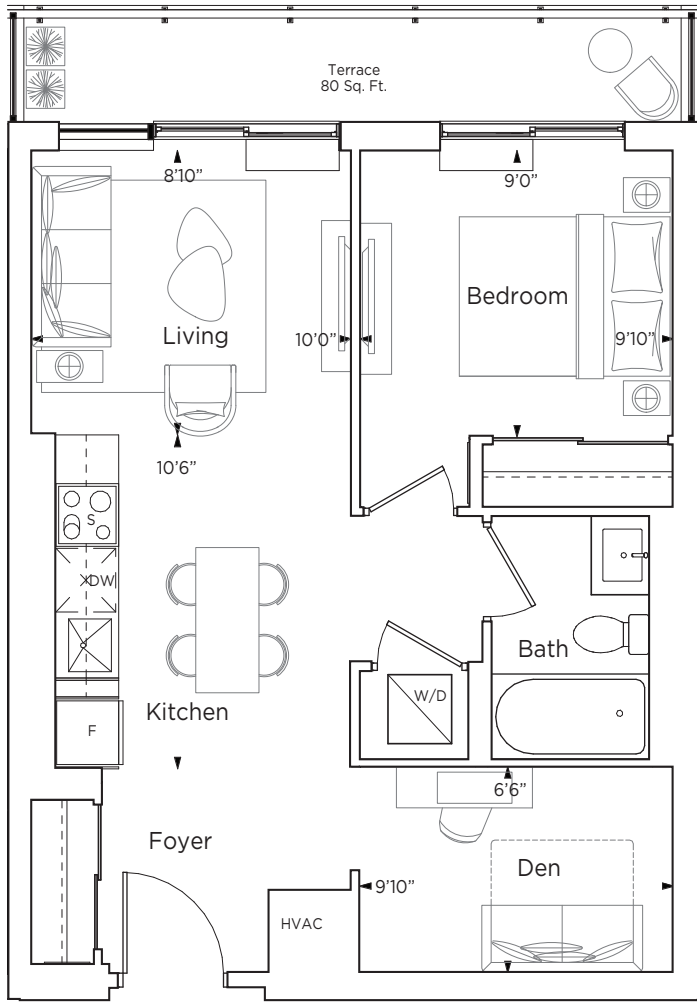

C19-1

TOWER A
595 SQ.FT.

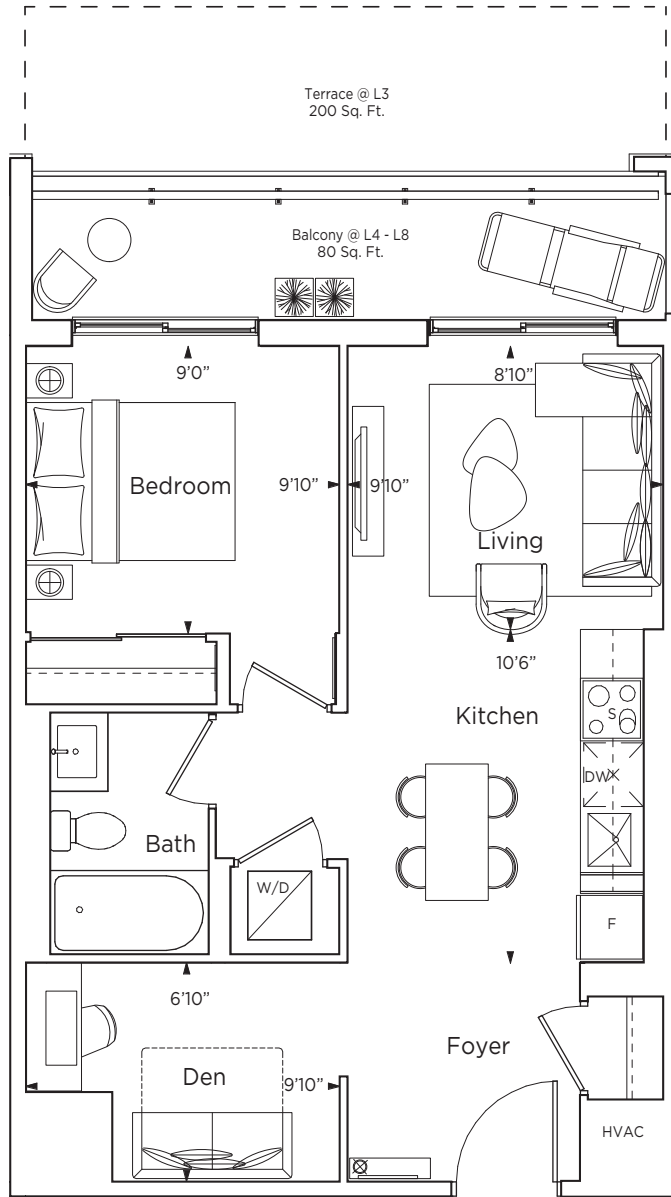

C19-2

TOWER B
577 SQ.FT.

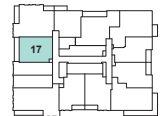

Tower B
LEVEL 7 - 8



Tower B
LEVEL 6

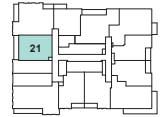

Tower B
LEVEL 5

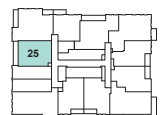

Tower B
LEVEL 4

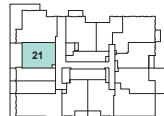

Tower B
LEVEL 3



Tower A
LEVEL 6



Vincent
CONDOMINIUMS



Materials, specifications and floor plans are subject to change. All renderings are artist's concept. All floor plans are approximate dimensions. Actual usable floor space may vary from stated floor area. Balcony/terrace areas may vary. Windows, room/area dimensions & square feet may vary due to location within building. Furniture not included. E. & O. E.

ONE BED + DEN

GENEVA

580 SQ.FT.

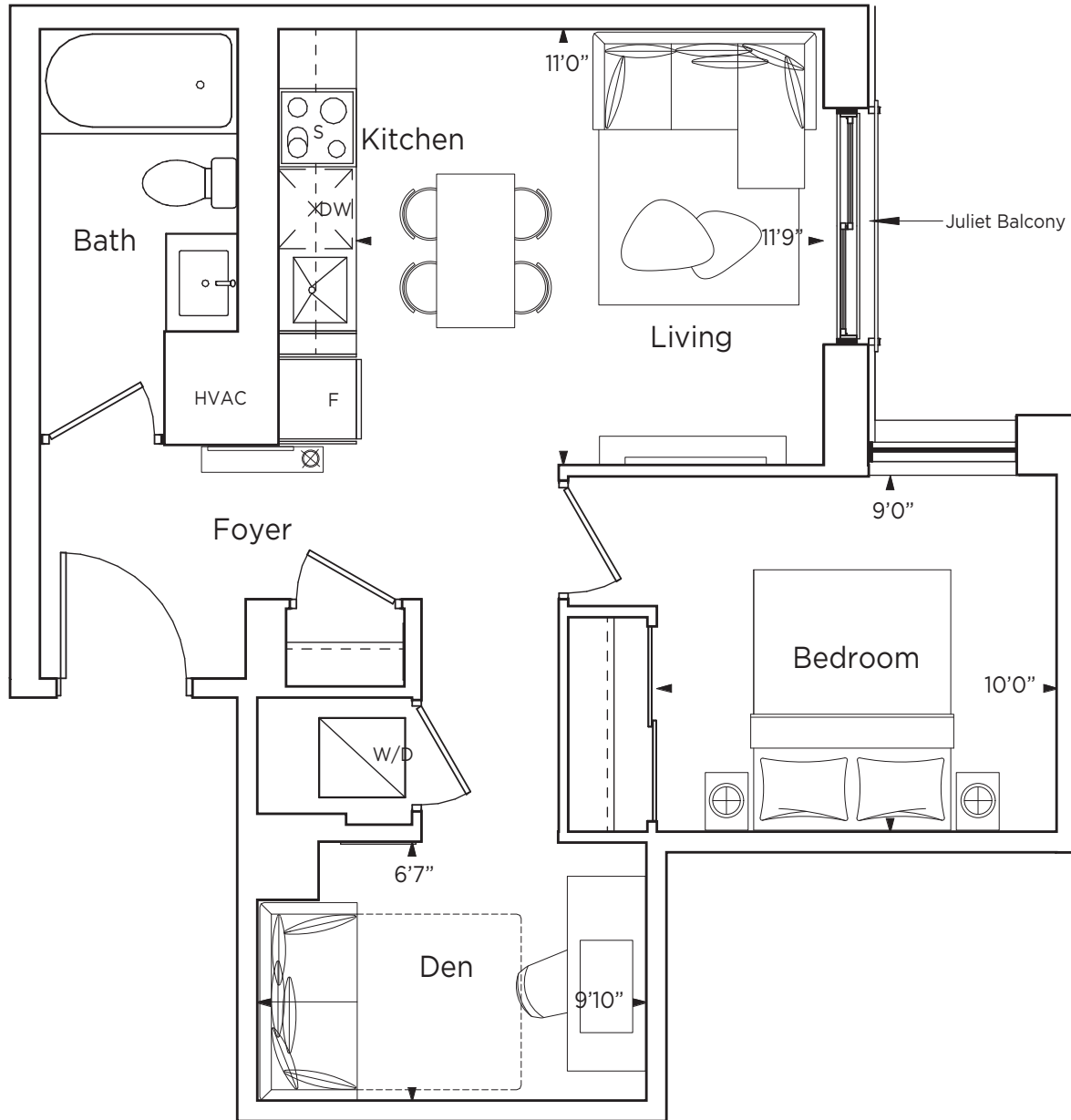

B24

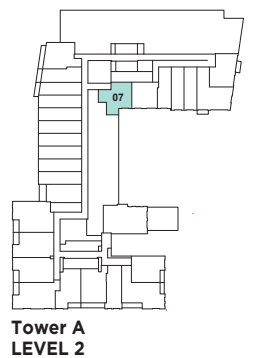

Materials, specifications and floor plans are subject to change. All renderings are artist's concept. All floor plans are approximate dimensions. Actual usable floor space may vary from stated floor area. Balcony/terrace areas may vary. Windows, room/area dimensions & square feet may vary due to location within building. Furniture not included. E. & O. E.

ONE BED + DEN

HAMBURG

590 SQ.FT. • 77 SQ.FT. BALCONY

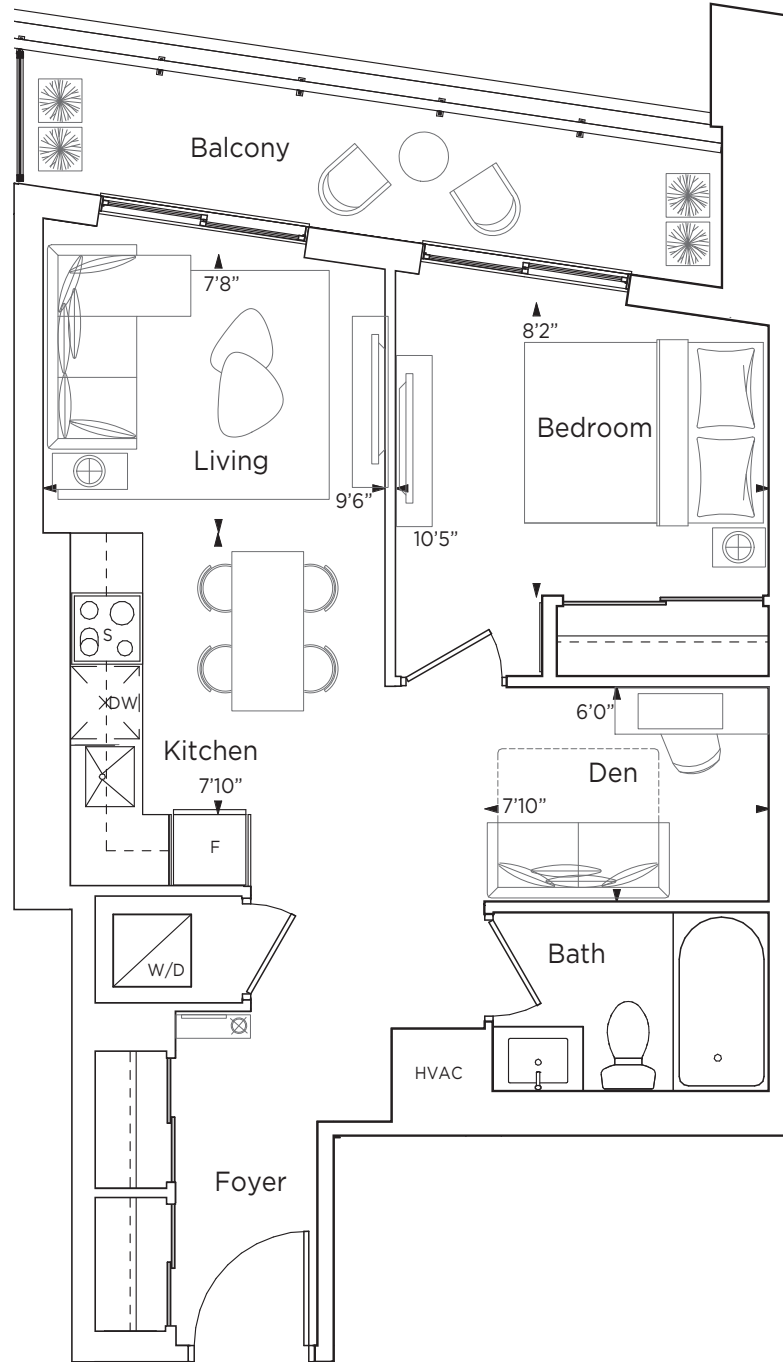

B1

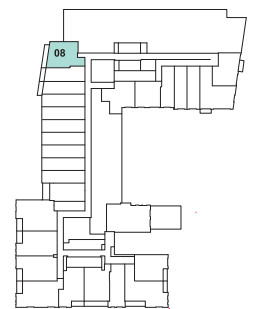

Tower A
LEVEL 2



Vincent
CONDOMINIUMS



Materials, specifications and floor plans are subject to change. All renderings are artist's concept. All floor plans are approximate dimensions. Actual usable floor space may vary from stated floor area. Balcony/terrace areas may vary. Windows, room/area dimensions & square feet may vary due to location within building. Furniture not included. E. & O. E.

ONE BED + DEN

HAVANA

593 SQ.FT. • 33 SQ.FT. BALCONY

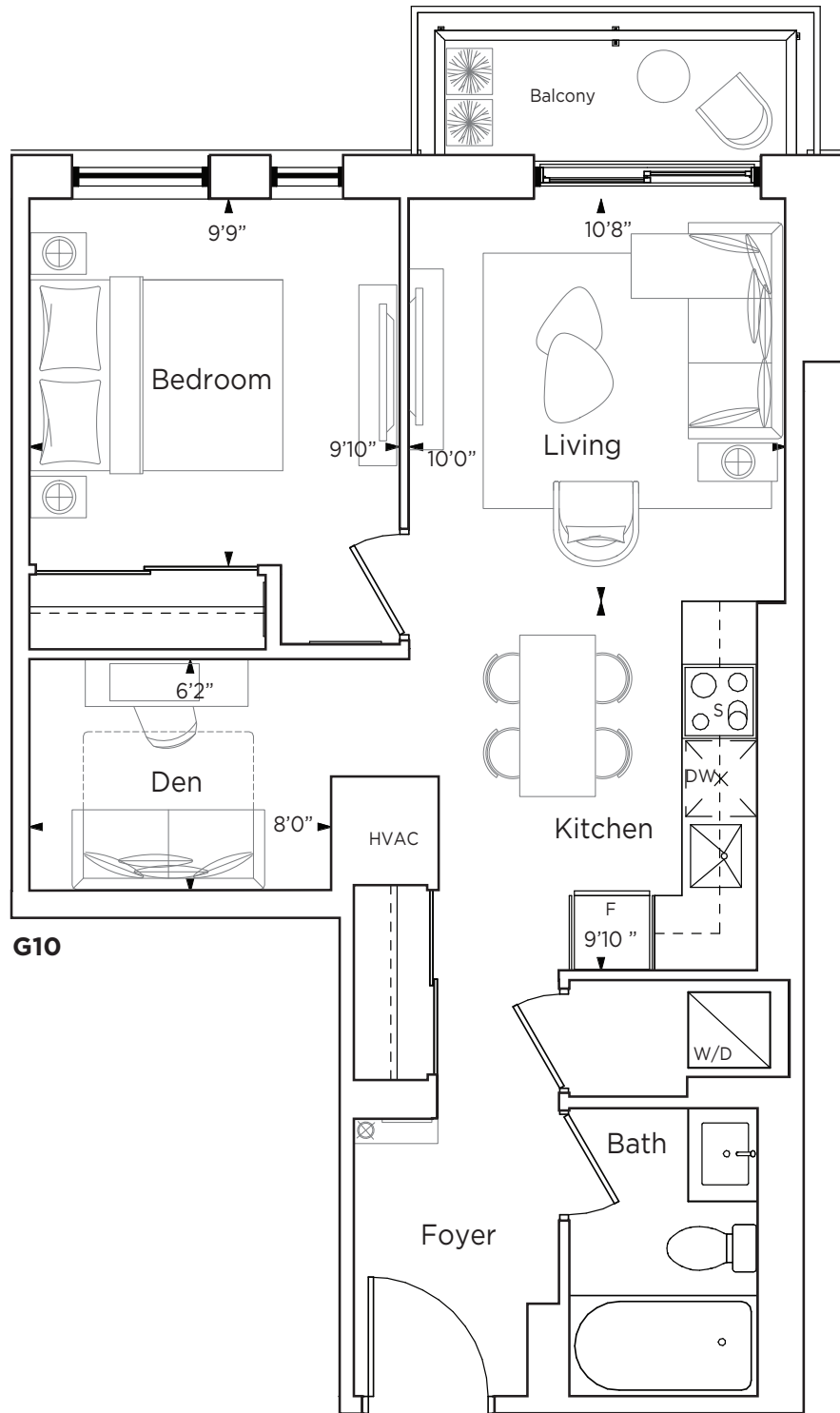

Vincent
CONDOMINIUMS

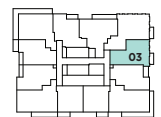

Tower A
LEVEL 7 - 14

Materials, specifications and floor plans are subject to change. All renderings are artist's concept. All floor plans are approximate dimensions. Actual usable floor space may vary from stated floor area. Balcony/terrace areas may vary. Windows, room/area dimensions & square feet may vary due to location within building. Furniture not included. E. & O. E.

ONE BED + DEN (BARRIER FREE)

HERRINGBONE

593 SQ.FT. • 85 SQ.FT. BALCONY

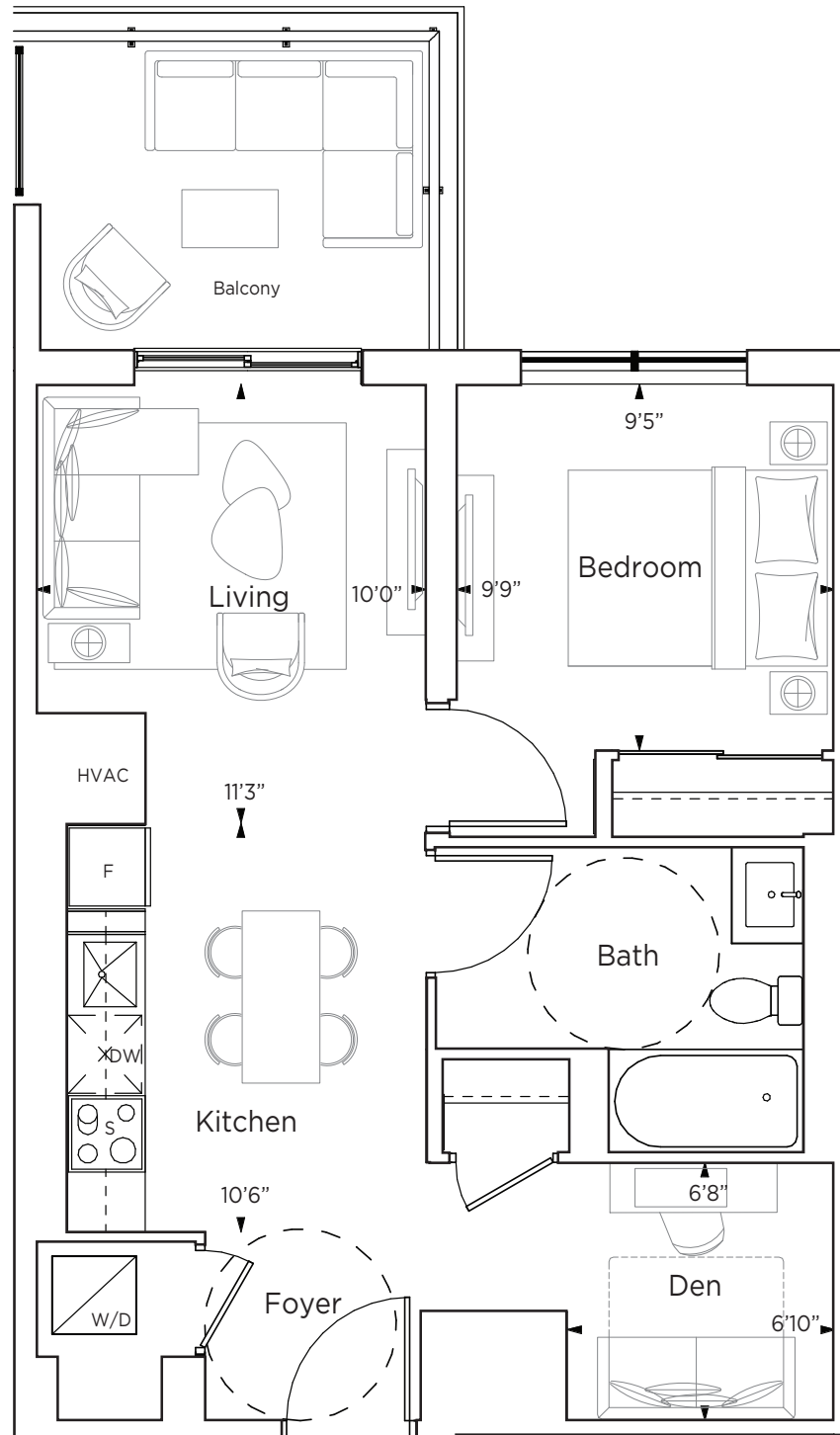

M6



Vincent
CONDOMINIUMS



Tower A
LEVEL 35 - 37

Materials, specifications and floor plans are subject to change. All renderings are artist's concept. All floor plans are approximate dimensions. Actual usable floor space may vary from stated floor area. Balcony/terrace areas may vary. Windows, room/area dimensions & square feet may vary due to location within building. Furniture not included. E. & O. E.

ONE BED + DEN (BARRIER-FREE)

ISTANBUL

600 SQ.FT. • 80 SQ.FT. TERRACE

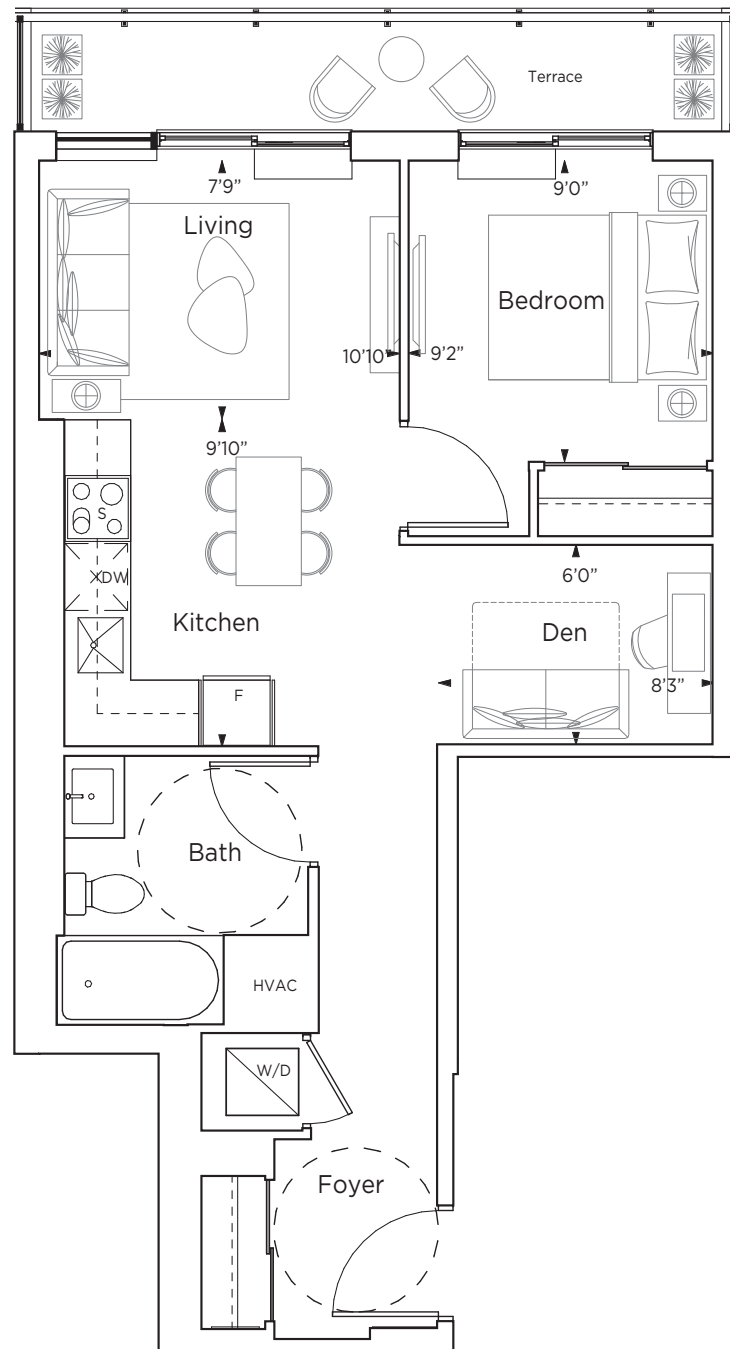

C16

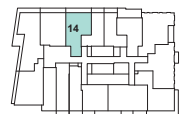

Tower A
LEVEL 6

Materials, specifications and floor plans are subject to change. All renderings are artist's concept. All floor plans are approximate dimensions. Actual usable floor space may vary from stated floor area. Balcony/terrace areas may vary. Windows, room/area dimensions & square feet may vary due to location within building. Furniture not included. E. & O. E.

ONE BED + DEN (BARRIER-FREE)

JACQUARD

600 SQ.FT. • 44 SQ.FT. BALCONY / TERRACE

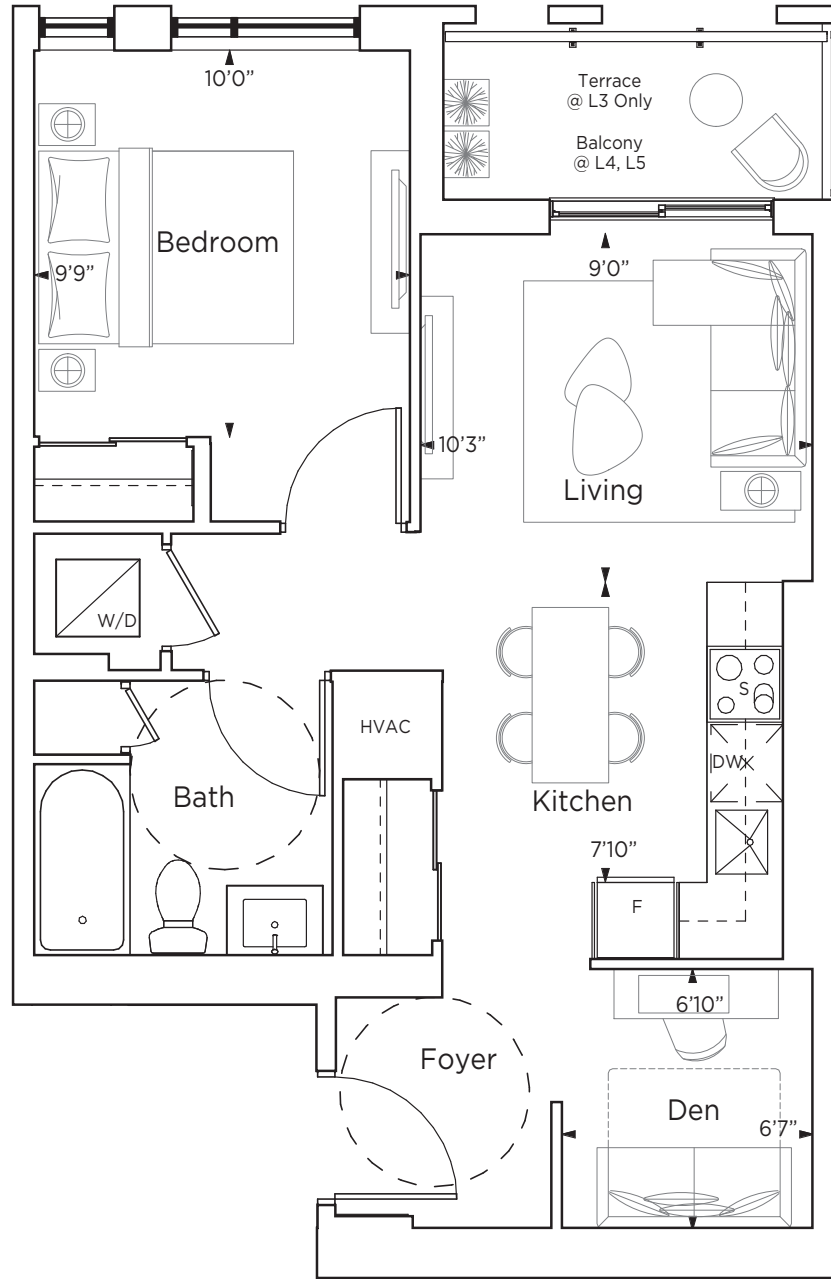

C3



Tower A
LEVEL 5



Tower A
LEVEL 4



Tower A
LEVEL 3



Vincent
CONDOMINIUMS



ONE BED + DEN (BARRIER-FREE)

KEY WEST

605 SQ.FT. • 77 SQ.FT. BALCONY • 88 SQ.FT. TERRACE

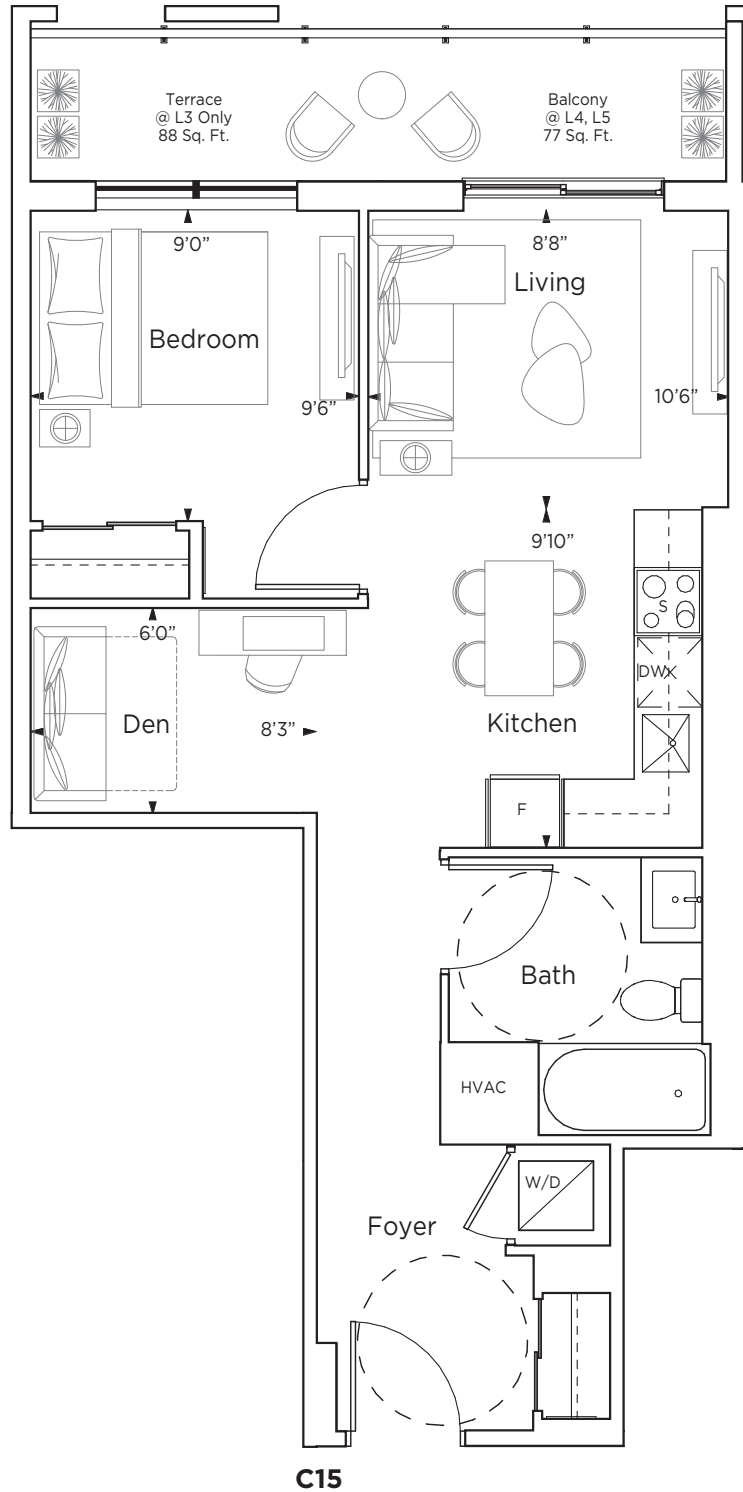

Tower A
LEVEL 5



Tower A
LEVEL 4

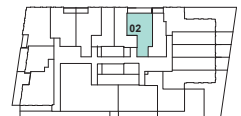

Tower A
LEVEL 3



Vincent
CONDOMINIUMS



Materials, specifications and floor plans are subject to change. All renderings are artist's concept. All floor plans are approximate dimensions. Actual usable floor space may vary from stated floor area. Balcony/terrace areas may vary. Windows, room/area dimensions & square feet may vary due to location within building. Furniture not included. E. & O. E.

ONE BED + DEN (BARRIER-FREE)

KINGSTON

608 SQ.FT. • 177 SQ.FT. BALCONY. • 514 SQ.FT. TERRACE

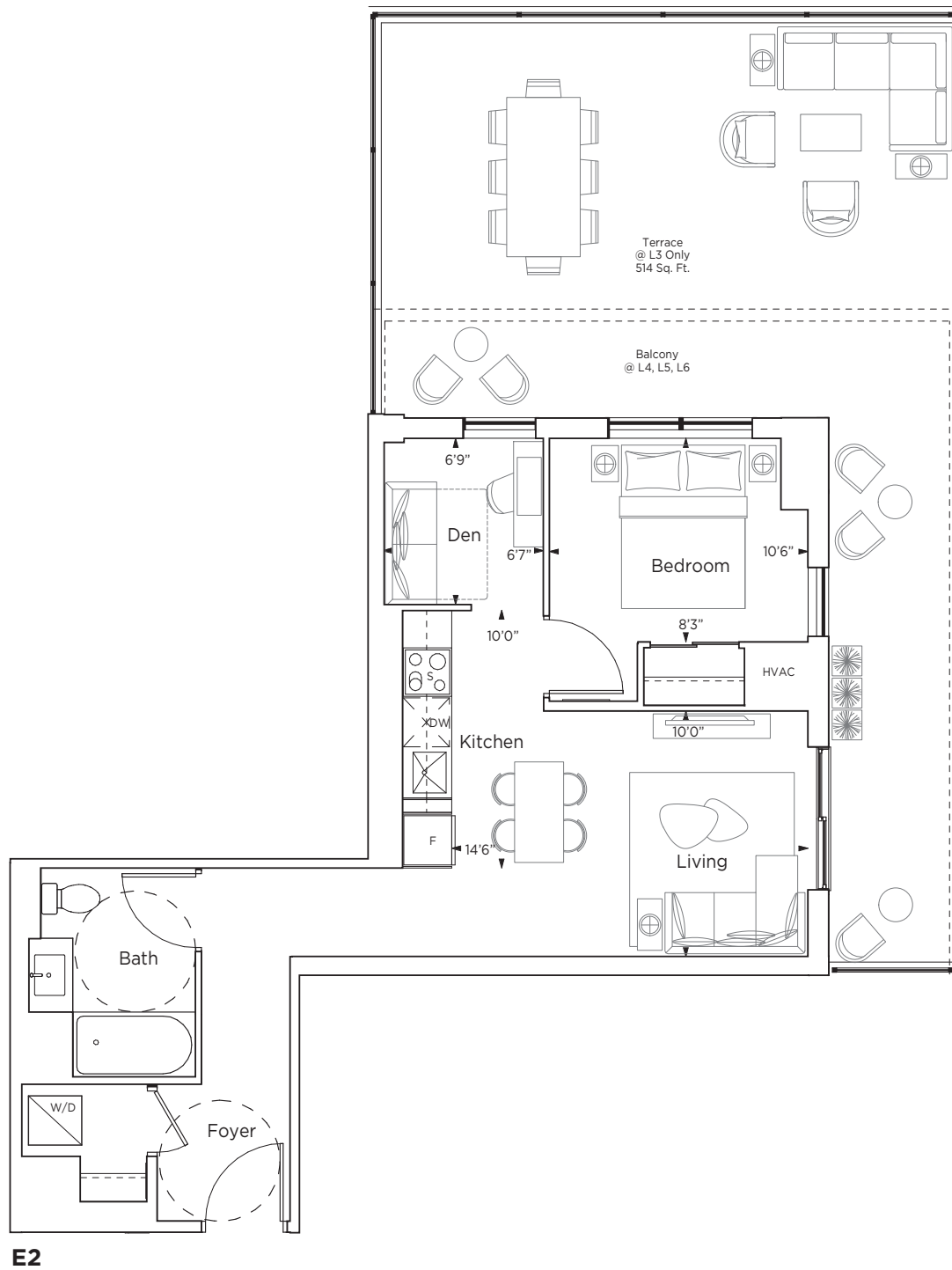

E2



Tower A
LEVEL 6



Tower A
LEVEL 5



Tower A
LEVEL 4



Tower A
LEVEL 3



Vincent
CONDOMINIUMS



ONE BED + DEN

LANGOUSTE

638 SQ.FT. • 579 SQ.FT. TERRACE

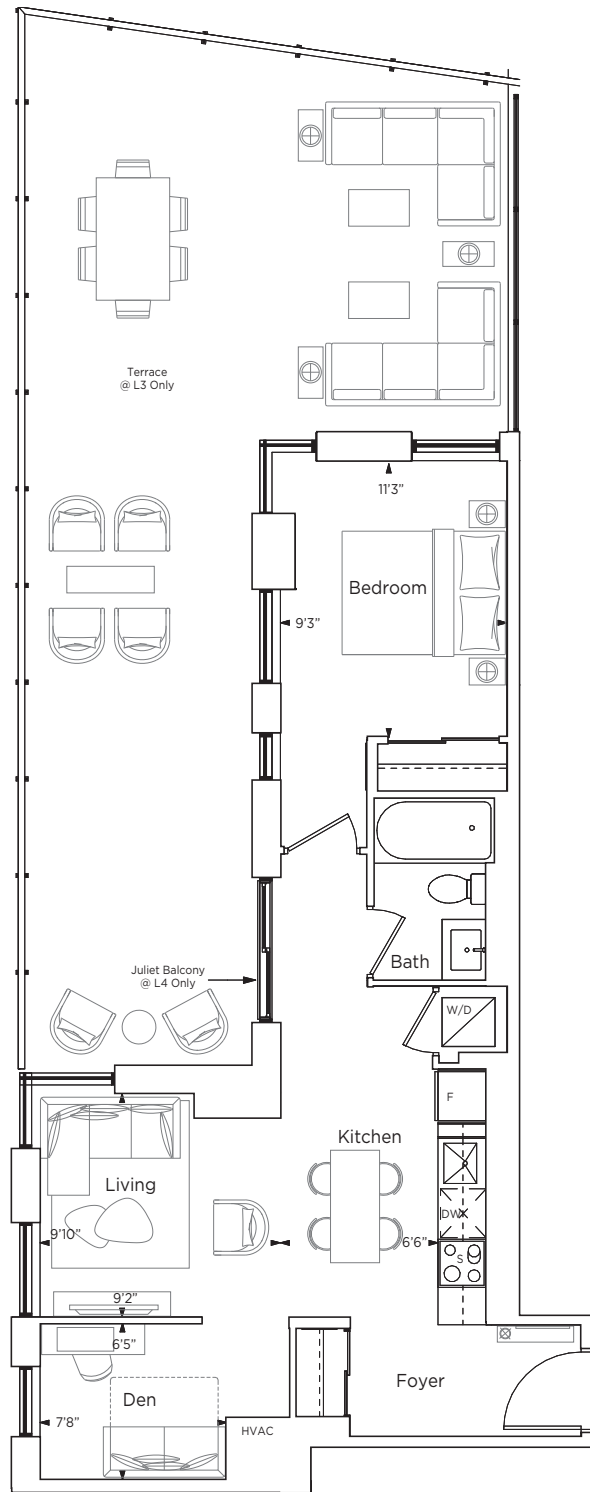

C13



Tower A
LEVEL 4

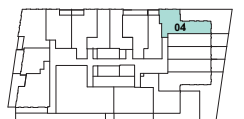

Tower A
LEVEL 3



Vincent
CONDOMINIUMS



Materials, specifications and floor plans are subject to change. All renderings are artist's concept. All floor plans are approximate dimensions. Actual usable floor space may vary from stated floor area. Balcony/terrace areas may vary. Windows, room/area dimensions & square feet may vary due to location within building. Furniture not included. E. & O. E.

ONE BED + DEN (BARRIER-FREE)

LAS VEGAS

655 SQ.FT. • 44 SQ.FT. BALCONY / TERRACE

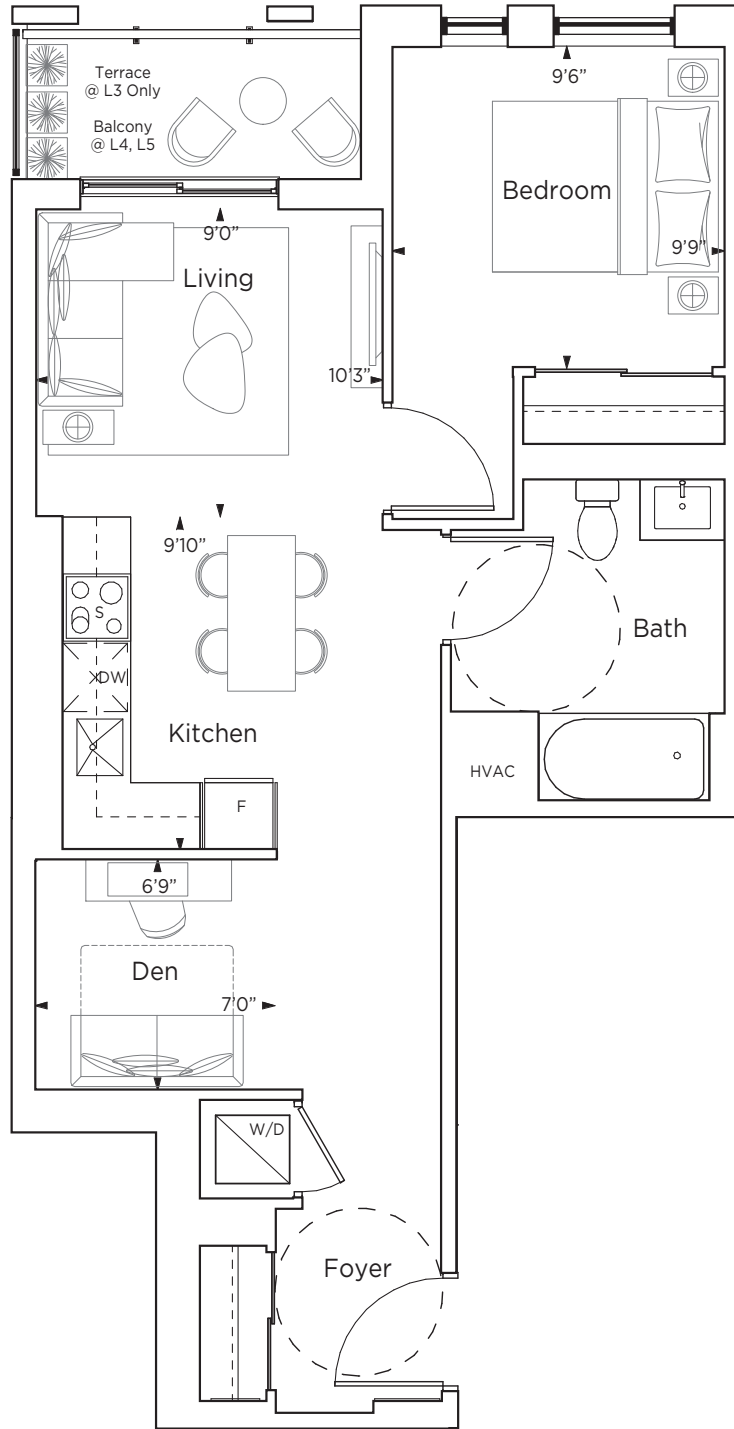

C2

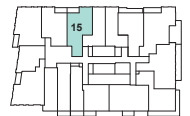

Tower A
LEVEL 5

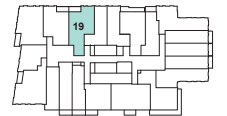

Tower A
LEVEL 4

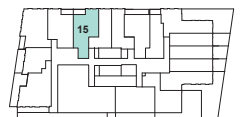

Tower A
LEVEL 3



Vincent
CONDOMINIUMS



TWO BED

LOS ANGELES

699 SQ.FT. • 77 SQ.FT. BALCONY • 165 SQ.FT. TERRACE

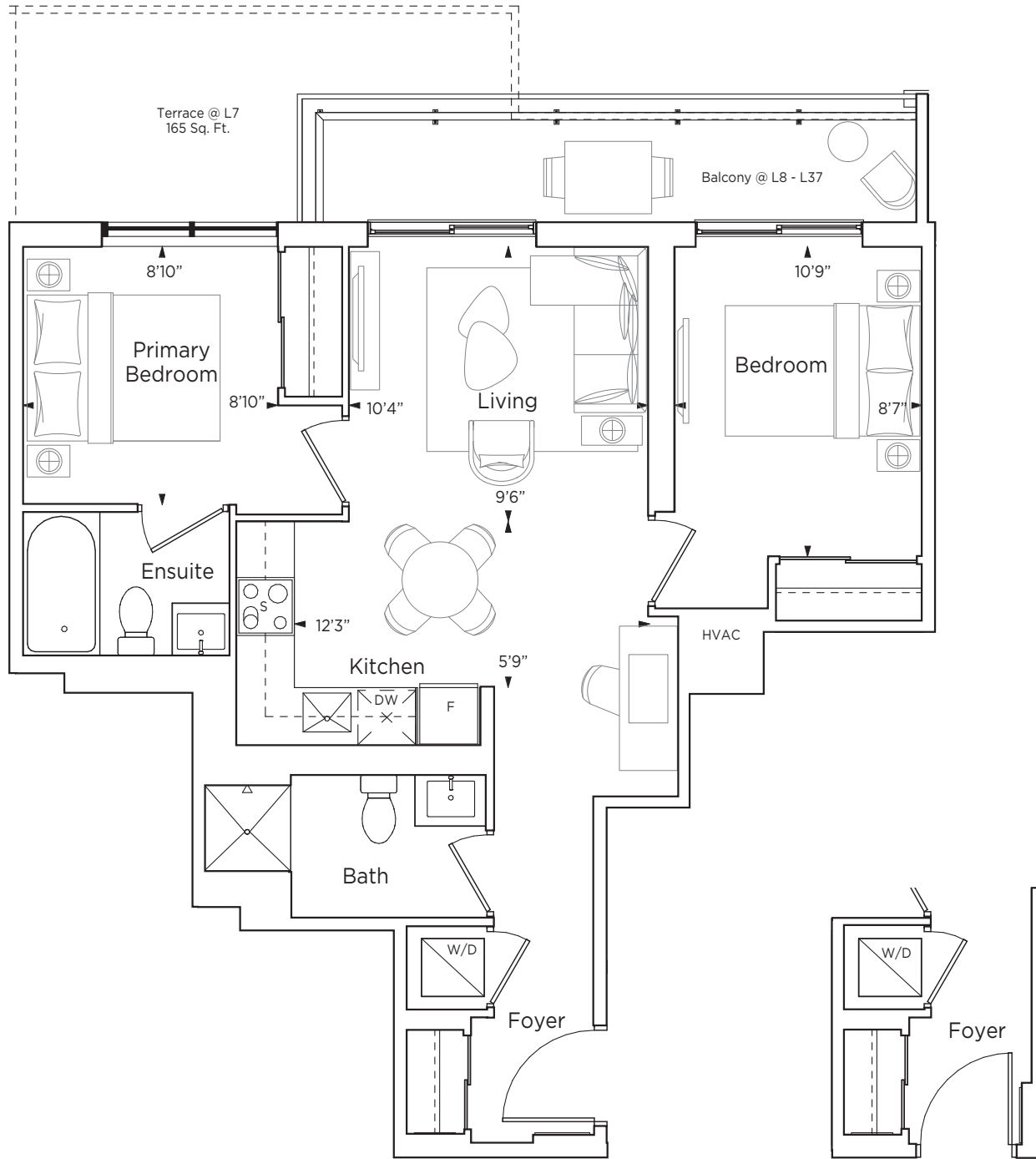

G12

ENTRANCE
AT LEVEL 35 - 37



Tower A
LEVEL 35 - 37



Tower A
LEVEL 15 - 34



Tower A
LEVEL 8 - 14



Tower A
LEVEL 7



Vincent
CONDOMINIUMS



Materials, specifications and floor plans are subject to change. All renderings are artist's concept. All floor plans are approximate dimensions. Actual usable floor space may vary from stated floor area. Balcony/terrace areas may vary. Windows, room/area dimensions & square feet may vary due to location within building. Furniture not included. E. & O. E.

TWO BED

LUXOR

704 SQ.FT. • 67 SQ.FT. TERRACE

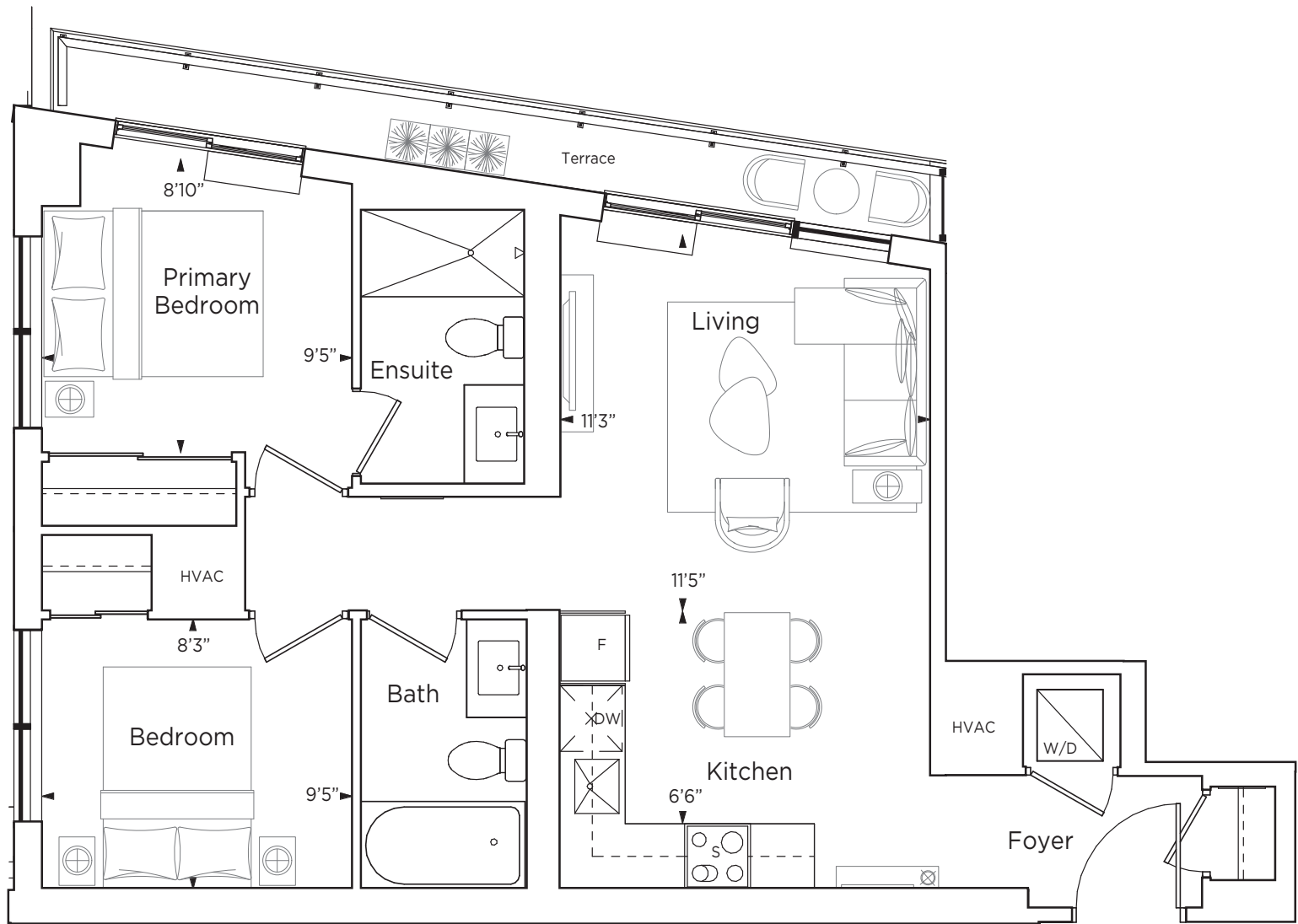

F5



Tower A
LEVEL 6

Materials, specifications and floor plans are subject to change. All renderings are artist's concept. All floor plans are approximate dimensions. Actual usable floor space may vary from stated floor area. Balcony/terrace areas may vary. Windows, room/area dimensions & square feet may vary due to location within building. Furniture not included. E. & O. E.

TWO BED

MAUI

706 SQ.FT. • 239 SQ.FT. BALCONY • 67 SQ.FT. TERRACE - TOWER A
706 SQ.FT. • 238 SQ.FT. BALCONY • 217 SQ.FT. TERRACE - TOWER B

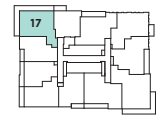
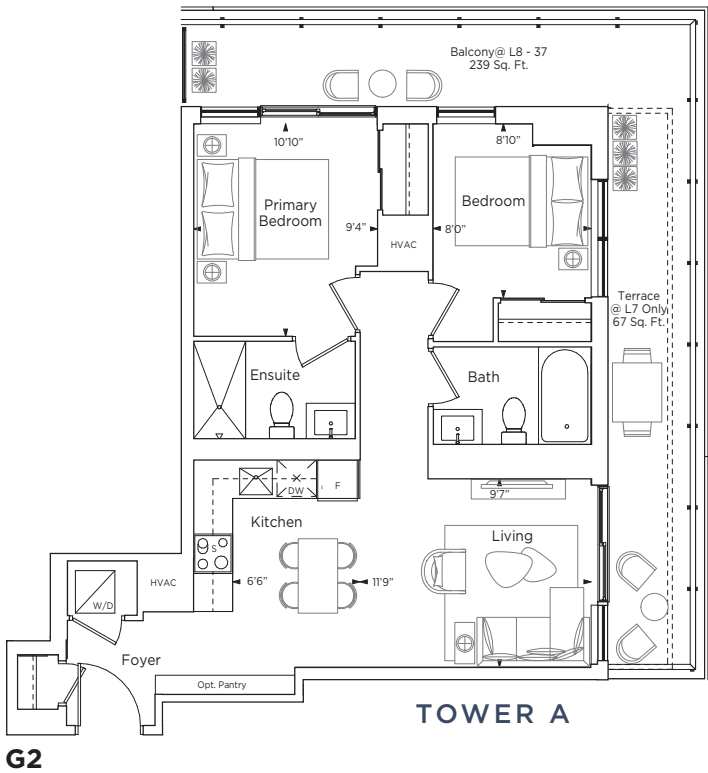
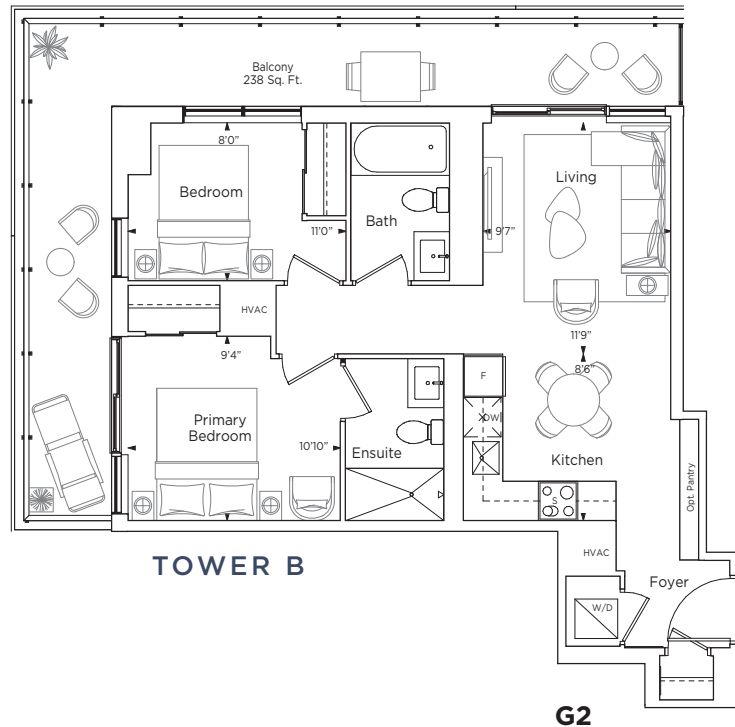
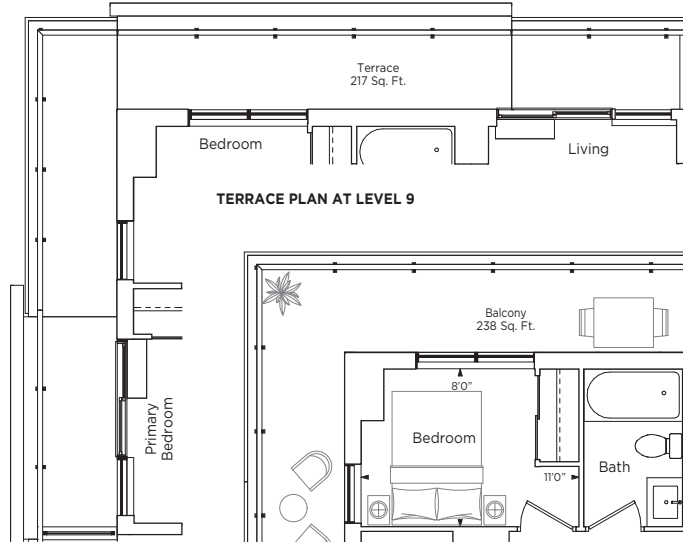

Tower B
LEVEL 25 - 27

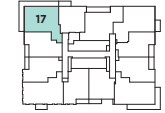

Tower B
LEVEL 15 - 24

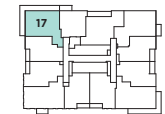

Tower B
LEVEL 10 - 14

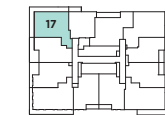

Tower B
LEVEL 9

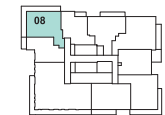

Tower A
LEVEL 35-37



Tower A
LEVEL 8-34



Tower A
LEVEL 7



Vincent
CONDOMINIUMS



Materials, specifications and floor plans are subject to change. All renderings are artist's concept. All floor plans are approximate dimensions. Actual usable floor space may vary from stated floor area. Balcony/terrace areas may vary. Windows, room/area dimensions & square feet may vary due to location within building. Furniture not included. E. & O. E.

TWO BED
MONACO
 706 SQ.FT.

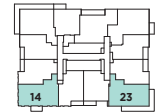
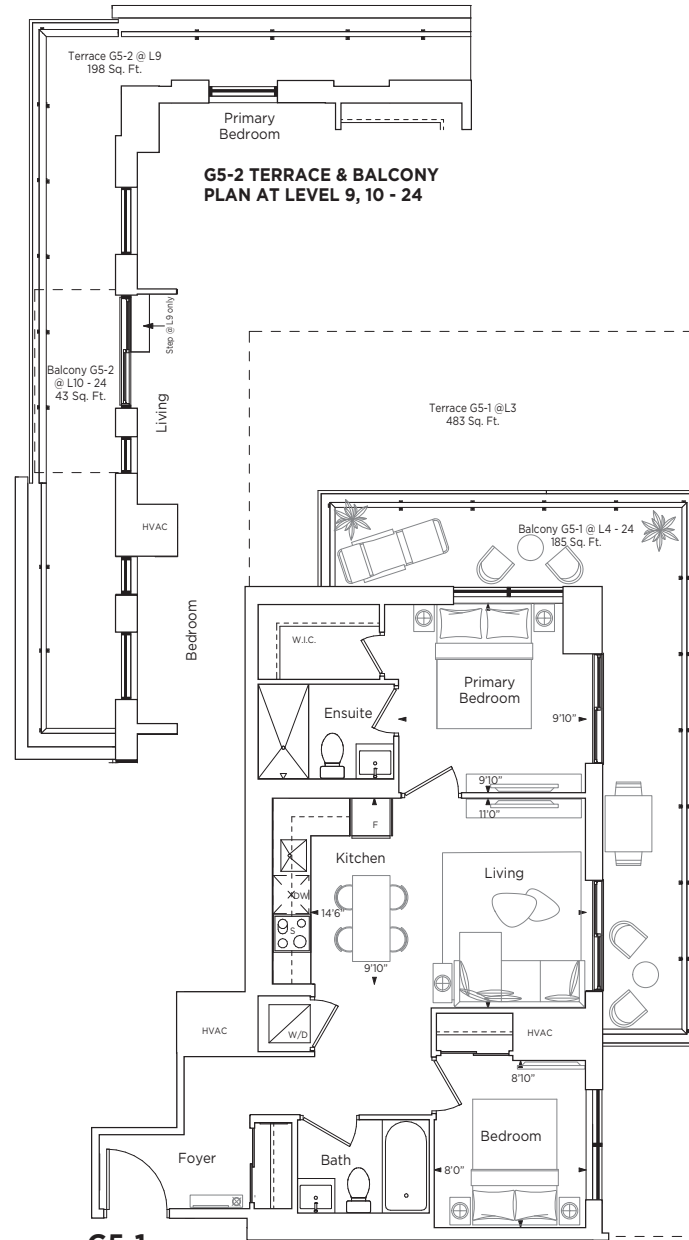
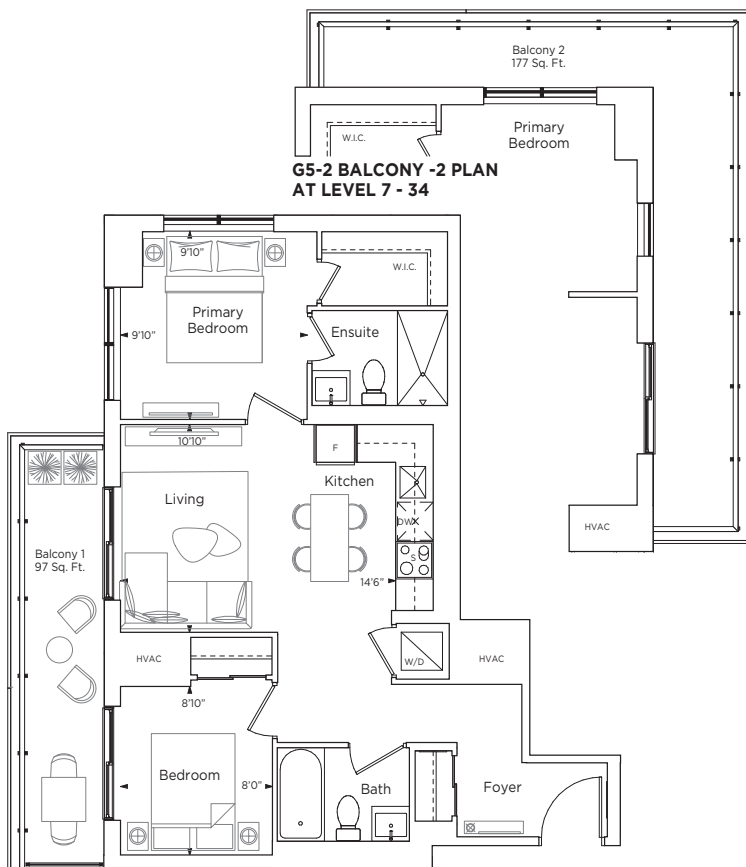

Tower B
 LEVEL 15 - 24



Tower B
 LEVEL 10 - 14

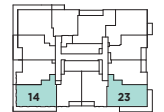

Tower B
 LEVEL 9

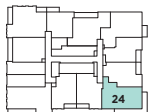

Tower B
 LEVEL 7 - 8

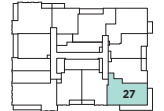

Tower B
 LEVEL 6

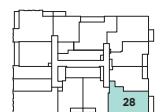

Tower B
 LEVEL 5

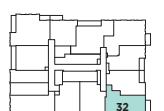

Tower B
 LEVEL 4



Tower B
 LEVEL 3



Tower A
 LEVEL 7 - 34



Materials, specifications and floor plans are subject to change. All renderings are artist's concept. All floor plans are approximate dimensions. Actual usable floor space may vary from stated floor area. Balcony/terrace areas may vary. Windows, room/area dimensions & square feet may vary due to location within building. Furniture not included. E. & O. E.

TWO BED

MONOGRAM

707 SQ.FT. • 47 SQ.FT. BALCONY / TERRACE

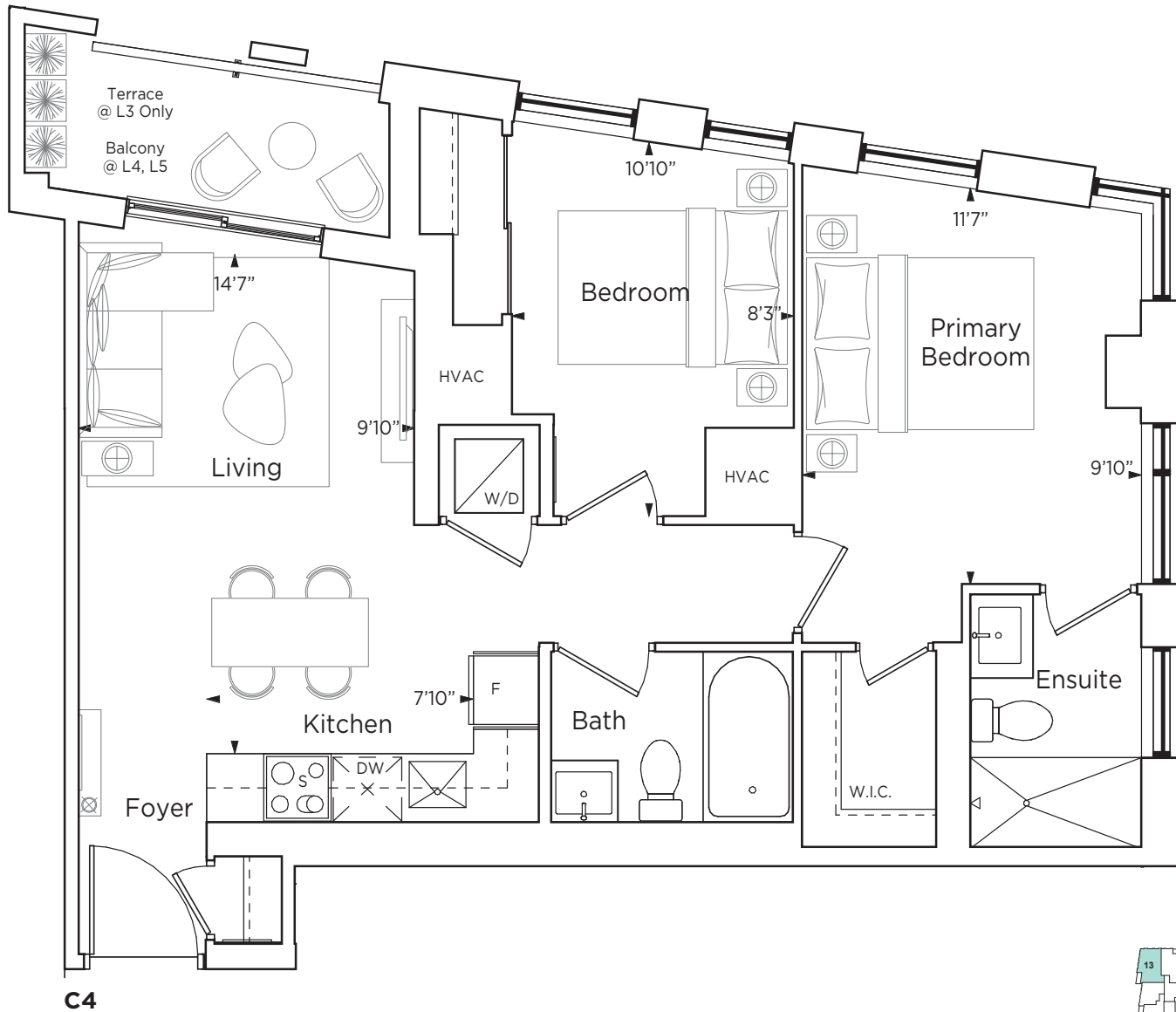

Tower A
LEVEL 5



Tower A
LEVEL 4



Tower A
LEVEL 3



Vincent
CONDOMINIUMS



TWO BED

MONTE CARLO

725 SQ. FT.

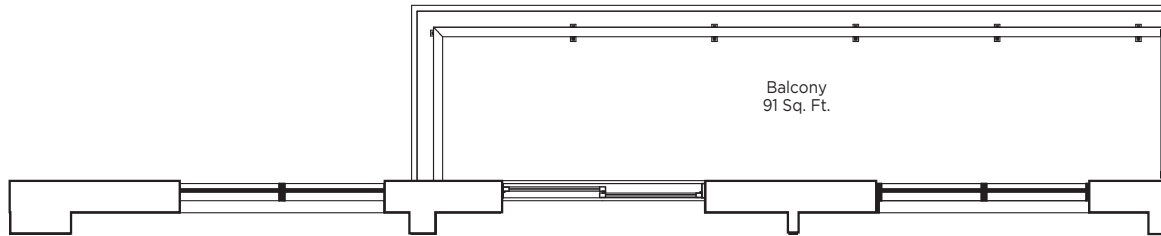

BALCONY PLAN AT LEVEL 35-37

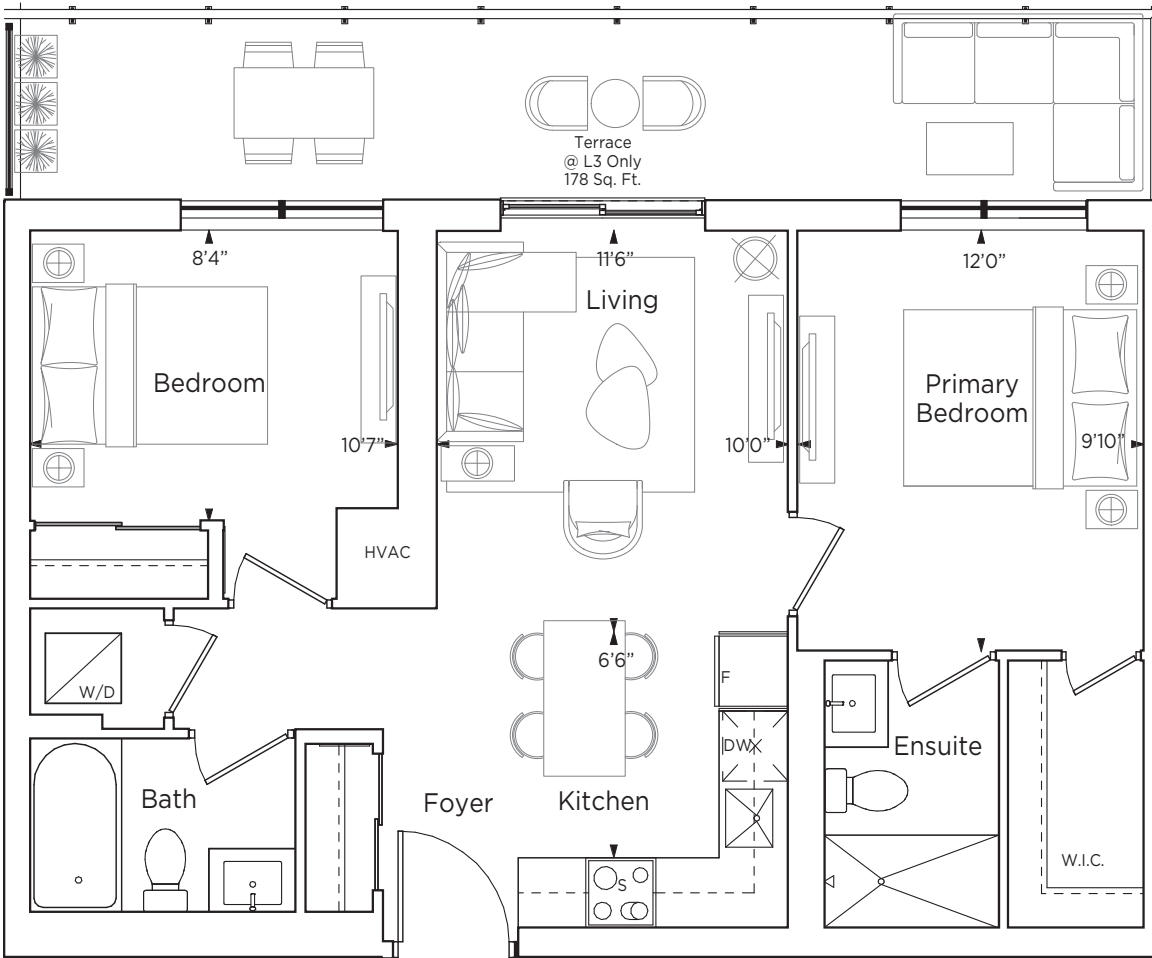

C7

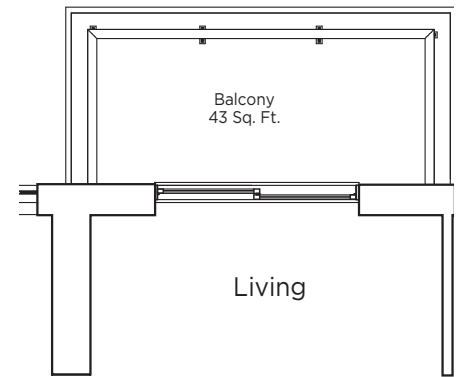

BALCONY PLAN AT LEVEL 4, 5, 6



**Tower A
LEVEL 35-37**



**Tower A
LEVEL 6**

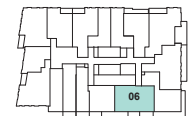

**Tower A
LEVEL 5**

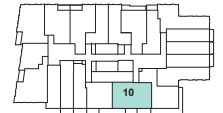

**Tower A
LEVEL 4**



**Tower A
LEVEL 3**



Materials, specifications and floor plans are subject to change. All renderings are artist's concept. All floor plans are approximate dimensions. Actual usable floor space may vary from stated floor area. Balcony/terrace areas may vary. Windows, room/area dimensions & square feet may vary due to location within building. Furniture not included. E. & O. E.

TWO BED

NASSAU

760 SQ.FT. D6-2 • 356 SQ.FT. TERRACE @ LEVEL 3

744 SQ.FT. D6-1

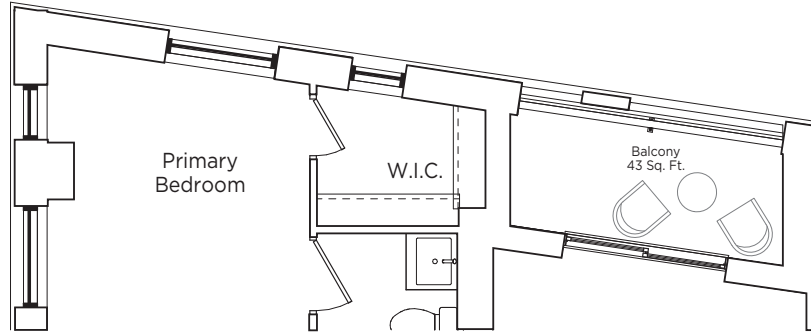

D6-1 BALCONY PLAN AT LEVEL 4, 5

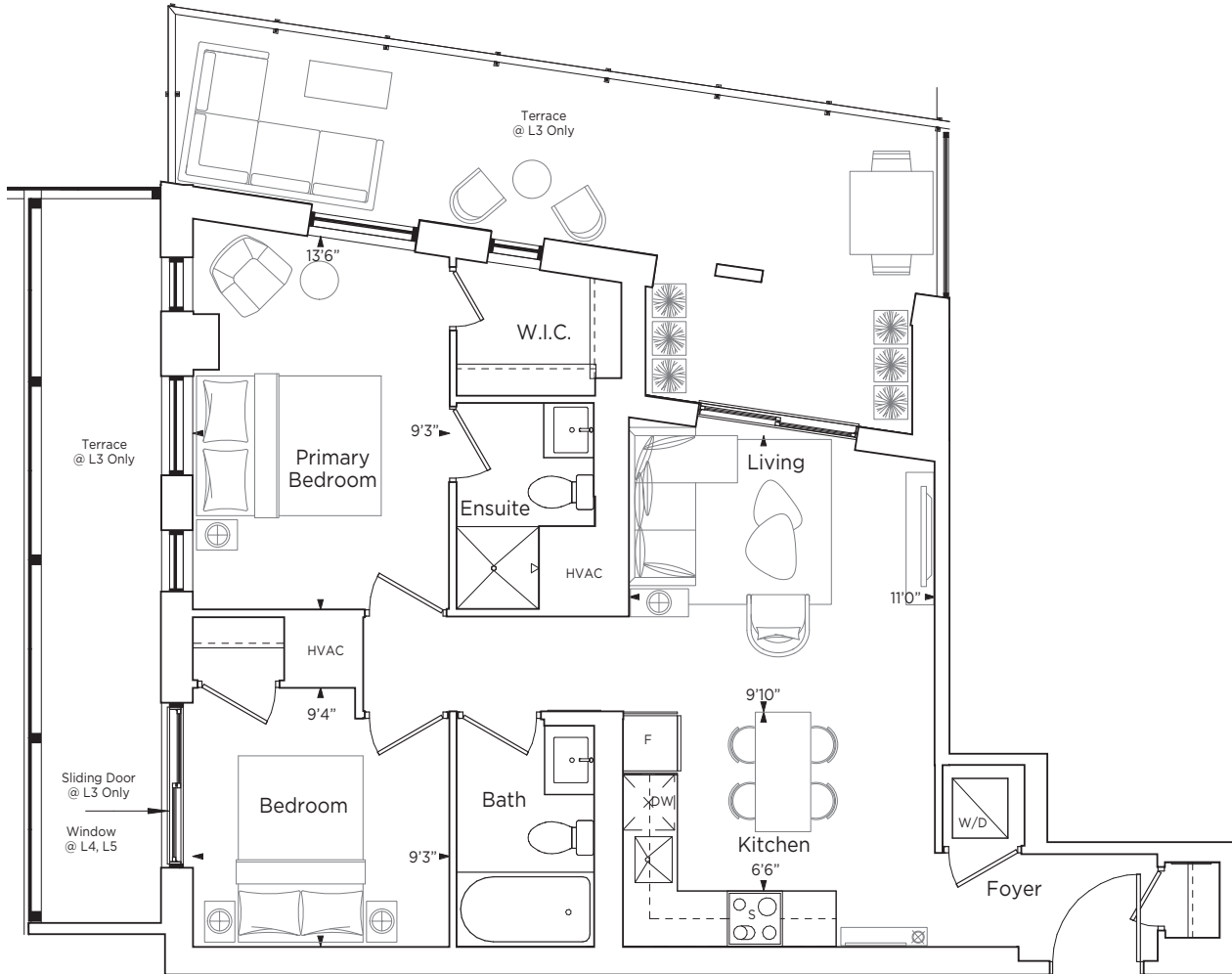

D6-2

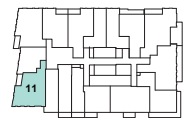

Tower A
LEVEL 5

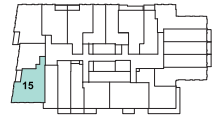

Tower A
LEVEL 4



Tower A
LEVEL 3



Vincent
CONDOMINIUMS



Materials, specifications and floor plans are subject to change. All renderings are artist's concept. All floor plans are approximate dimensions. Actual usable floor space may vary from stated floor area. Balcony/terrace areas may vary. Windows, room/area dimensions & square feet may vary due to location within building. Furniture not included. E. & O. E.

TWO BED

OMEGA

744 SQ.FT. • 177 SQ.FT. BALCONY

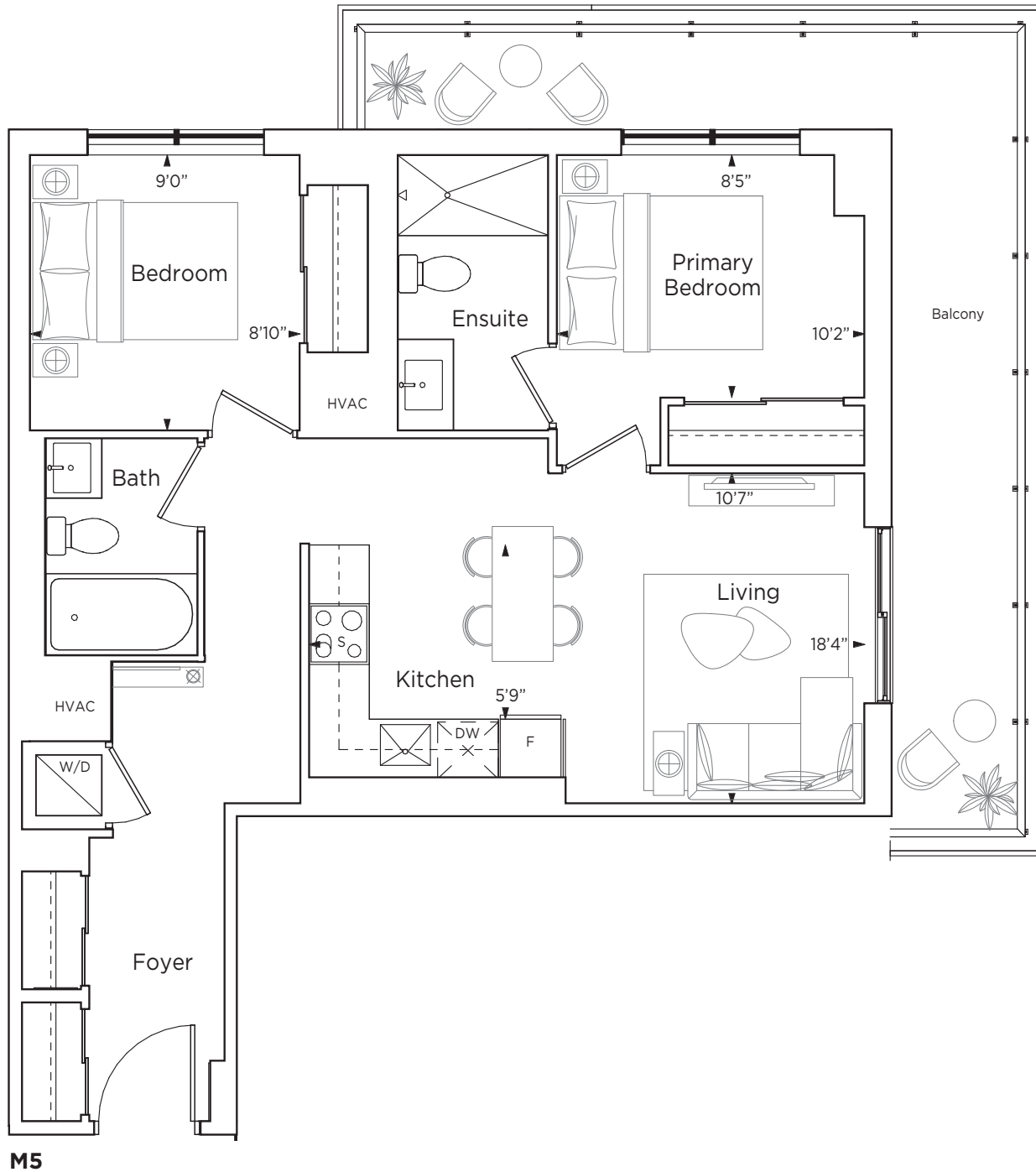

Vincent
CONDOMINIUMS

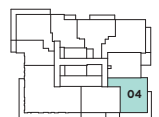

Tower A
LEVEL 35 - 37

Materials, specifications and floor plans are subject to change. All renderings are artist's concept. All floor plans are approximate dimensions. Actual usable floor space may vary from stated floor area. Balcony/terrace areas may vary. Windows, room/area dimensions & square feet may vary due to location within building. Furniture not included. E. & O. E.

TWO BED

OXFORD

746 SQ.FT. • 33 SQ.FT. BALCONY

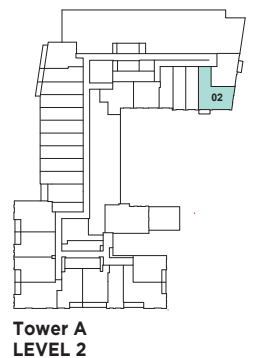
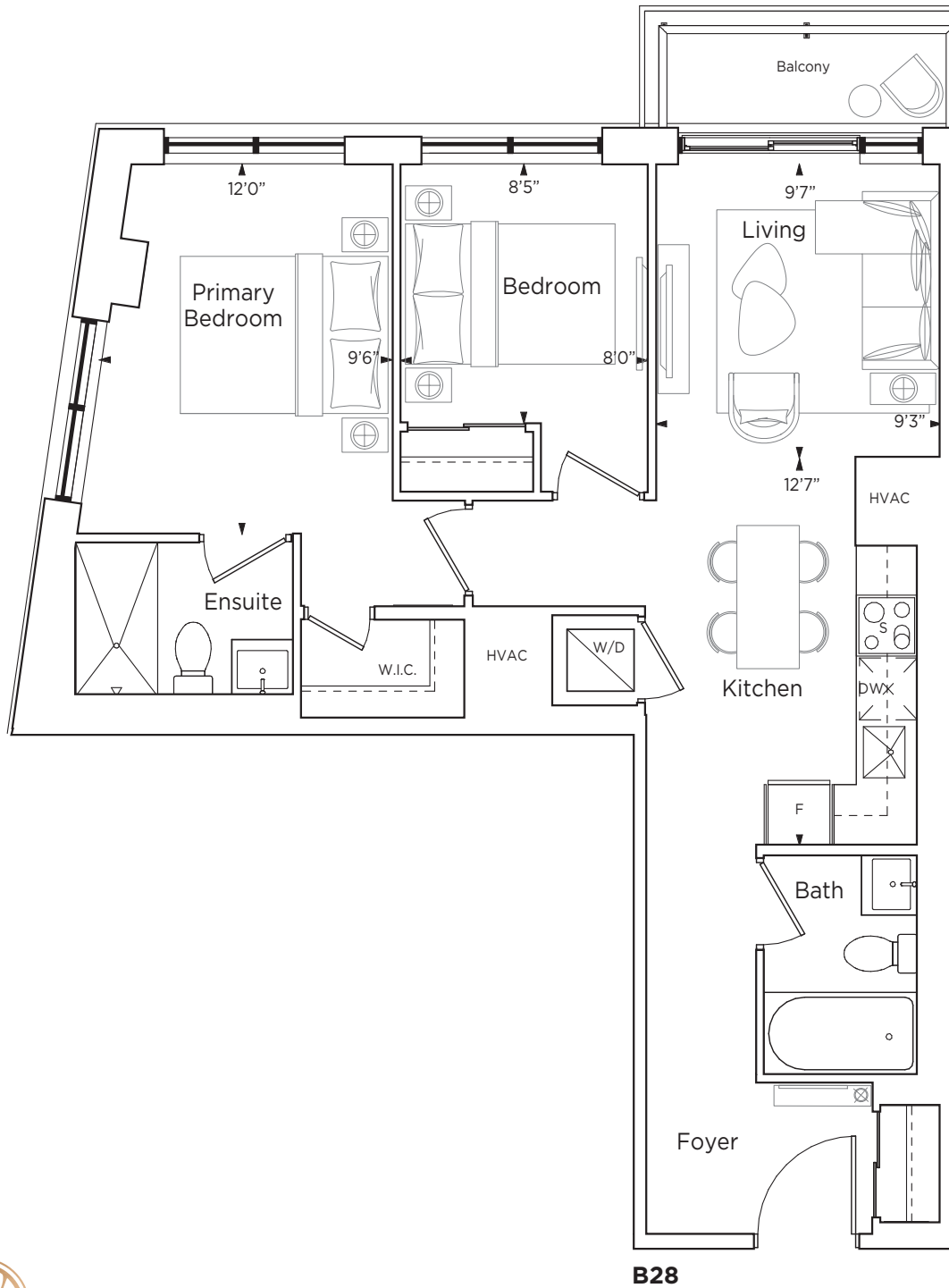

Materials, specifications and floor plans are subject to change. All renderings are artist's concept. All floor plans are approximate dimensions. Actual usable floor space may vary from stated floor area. Balcony/terrace areas may vary. Windows, room/area dimensions & square feet may vary due to location within building. Furniture not included. E. & O. E.

TWO BED (BARRIER-FREE)

QUANTUM

754 SQ.FT. • 33 SQ.FT. BALCONY

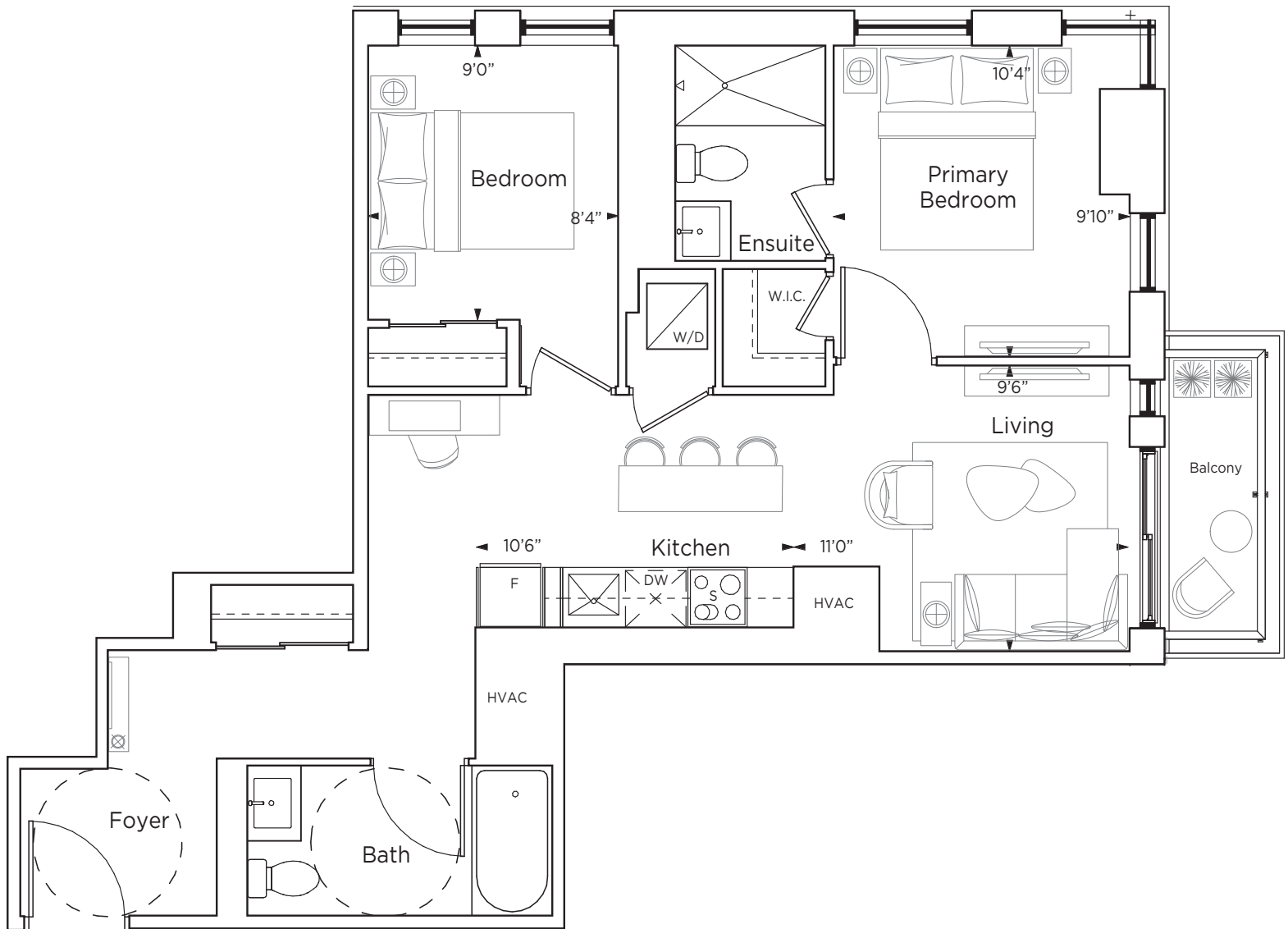

G11

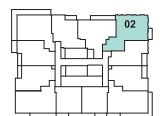

Tower A
LEVEL 15 - 34

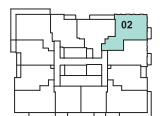

Tower A
LEVEL 7 - 14



Vincent
CONDOMINIUMS



TWO BED

RIO DE JANIERO

758 SQ.FT. • 66 SQ.FT. BALCONY

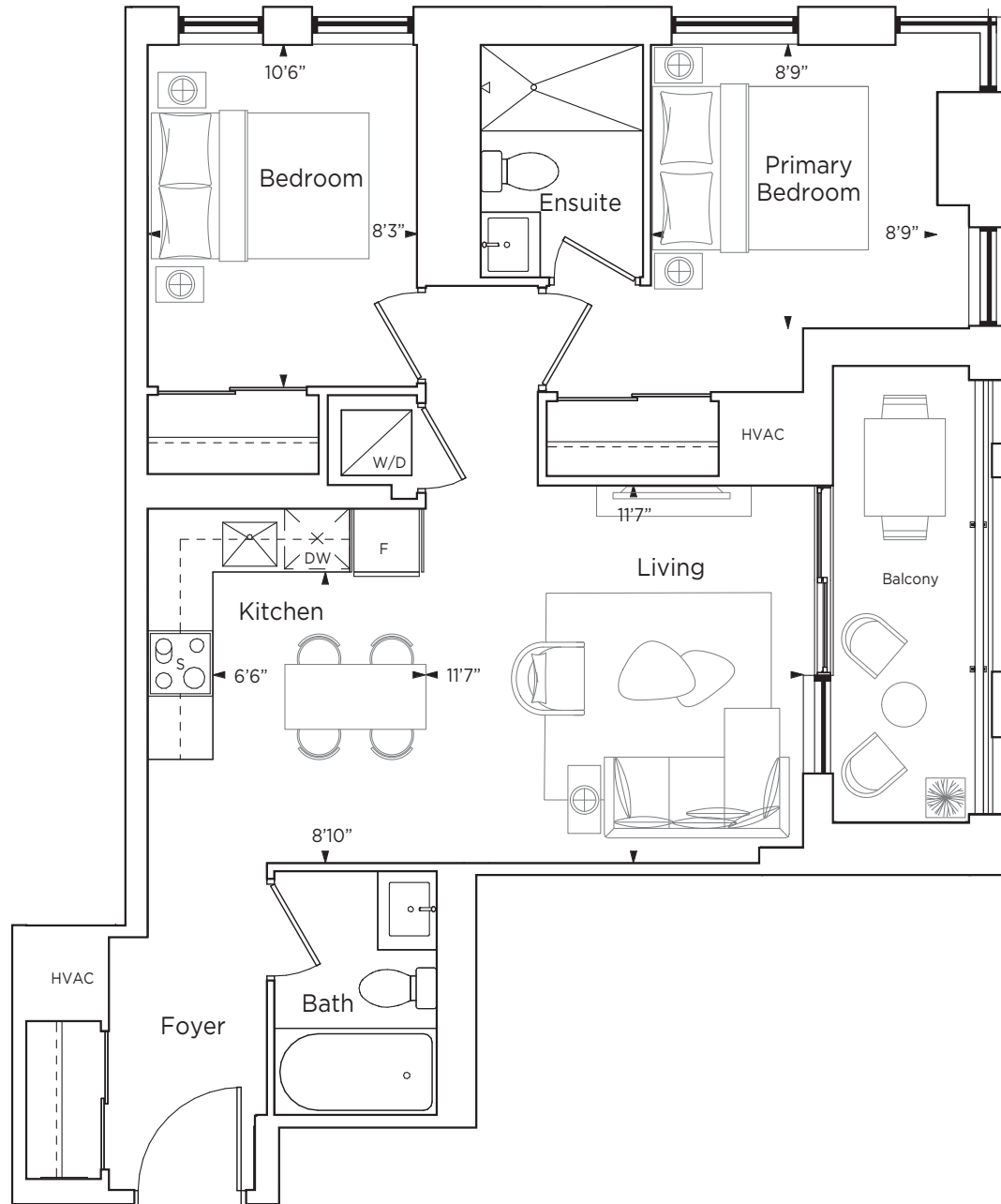

F13



Vincent
CONDOMINIUMS



Tower A
LEVEL 6

Materials, specifications and floor plans are subject to change. All renderings are artist's concept. All floor plans are approximate dimensions. Actual usable floor space may vary from stated floor area. Balcony/terrace areas may vary. Windows, room/area dimensions & square feet may vary due to location within building. Furniture not included. E. & O. E.

TWO BED

SAVILE ROW

802 SQ.FT. • 146 SQ.FT. TERRACE • 33 SQ.FT. BALCONY

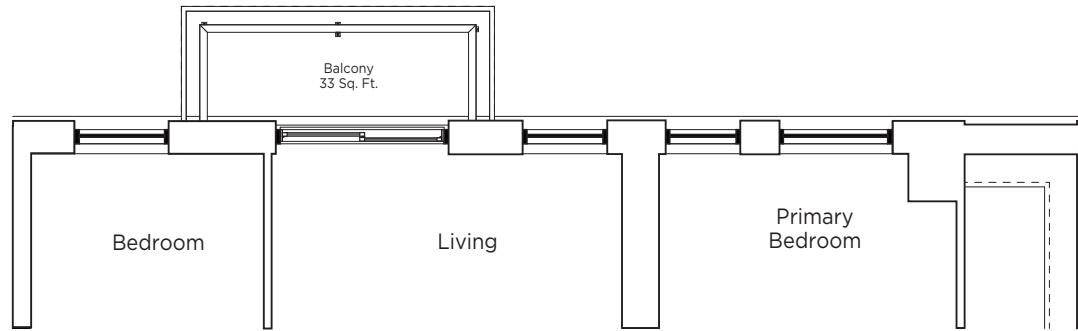

BALCONY PLAN AT LEVEL 6

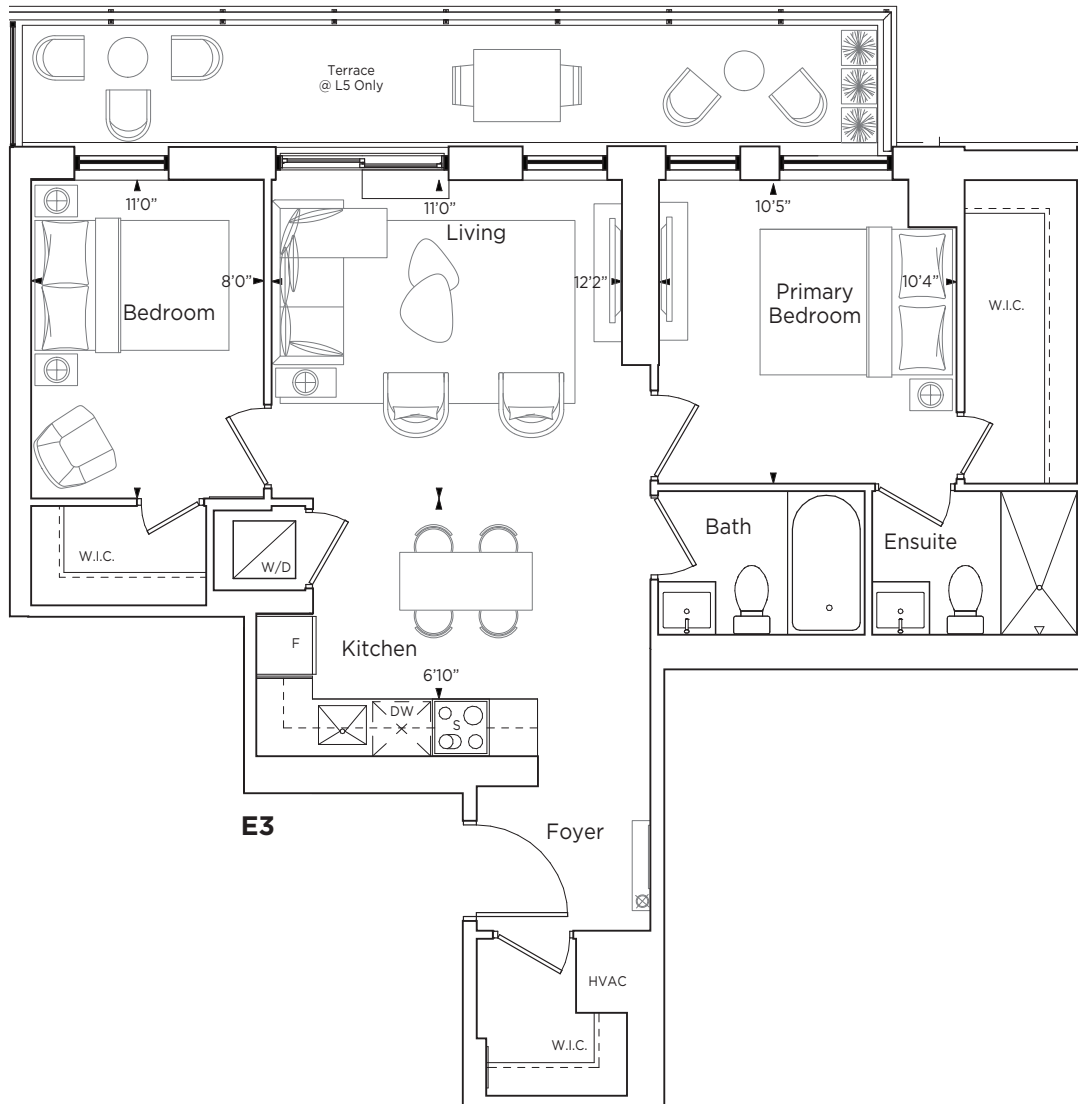

Tower A
LEVEL 6



Tower A
LEVEL 5



Vincent
CONDOMINIUMS



TWO BED

SCOTCH

805 SQ.FT. • 263 SQ.FT. TERRACE

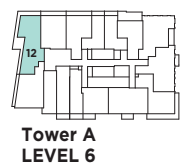
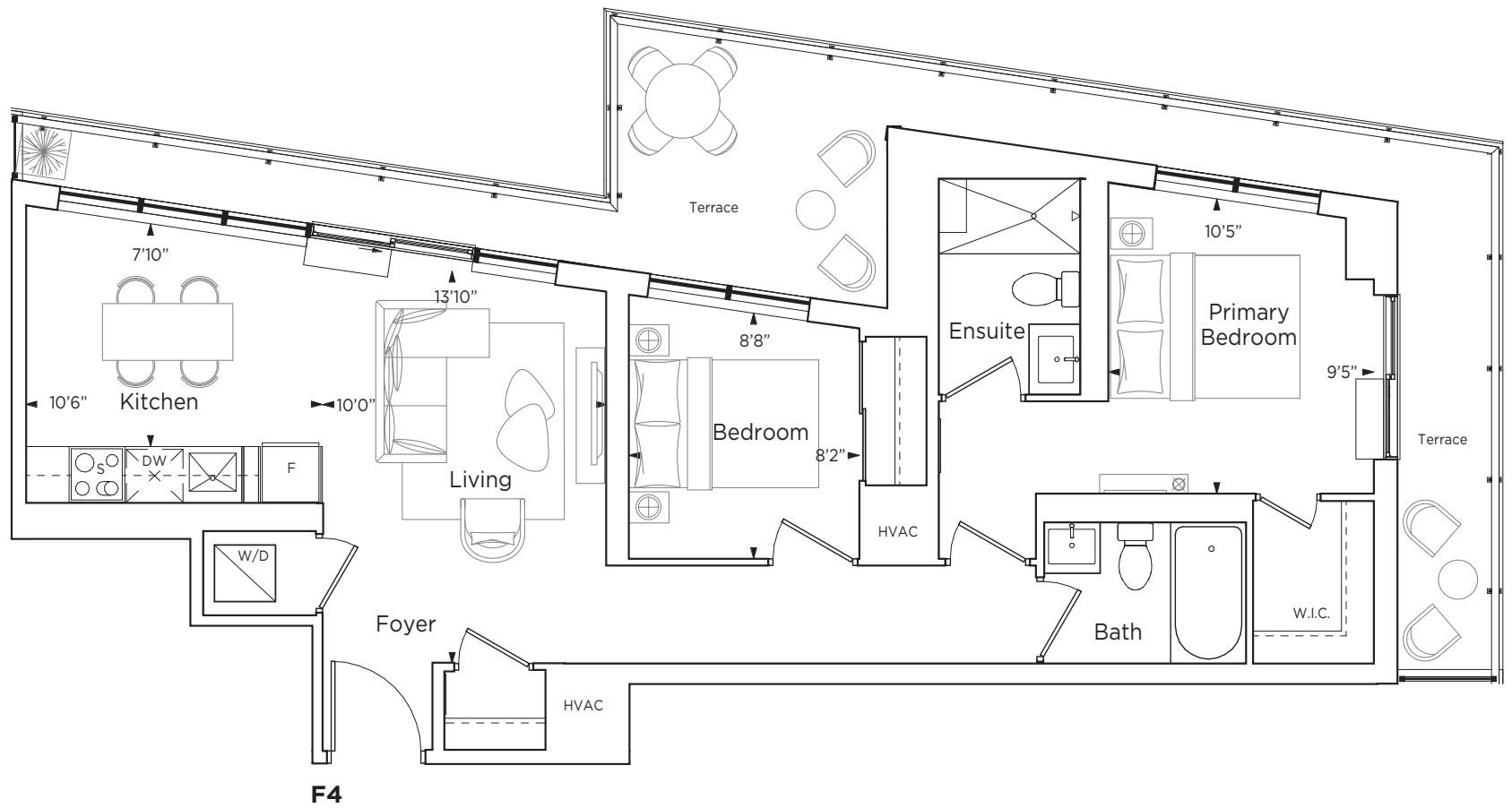

Materials, specifications and floor plans are subject to change. All renderings are artist's concept. All floor plans are approximate dimensions. Actual usable floor space may vary from stated floor area. Balcony/terrace areas may vary. Windows, room/area dimensions & square feet may vary due to location within building. Furniture not included. E. & O. E.

TWO BED

SILVER CLOUD

816 SQ.FT. • 65 SQ.FT. BALCONY • 167 SQ.FT. TERRACE

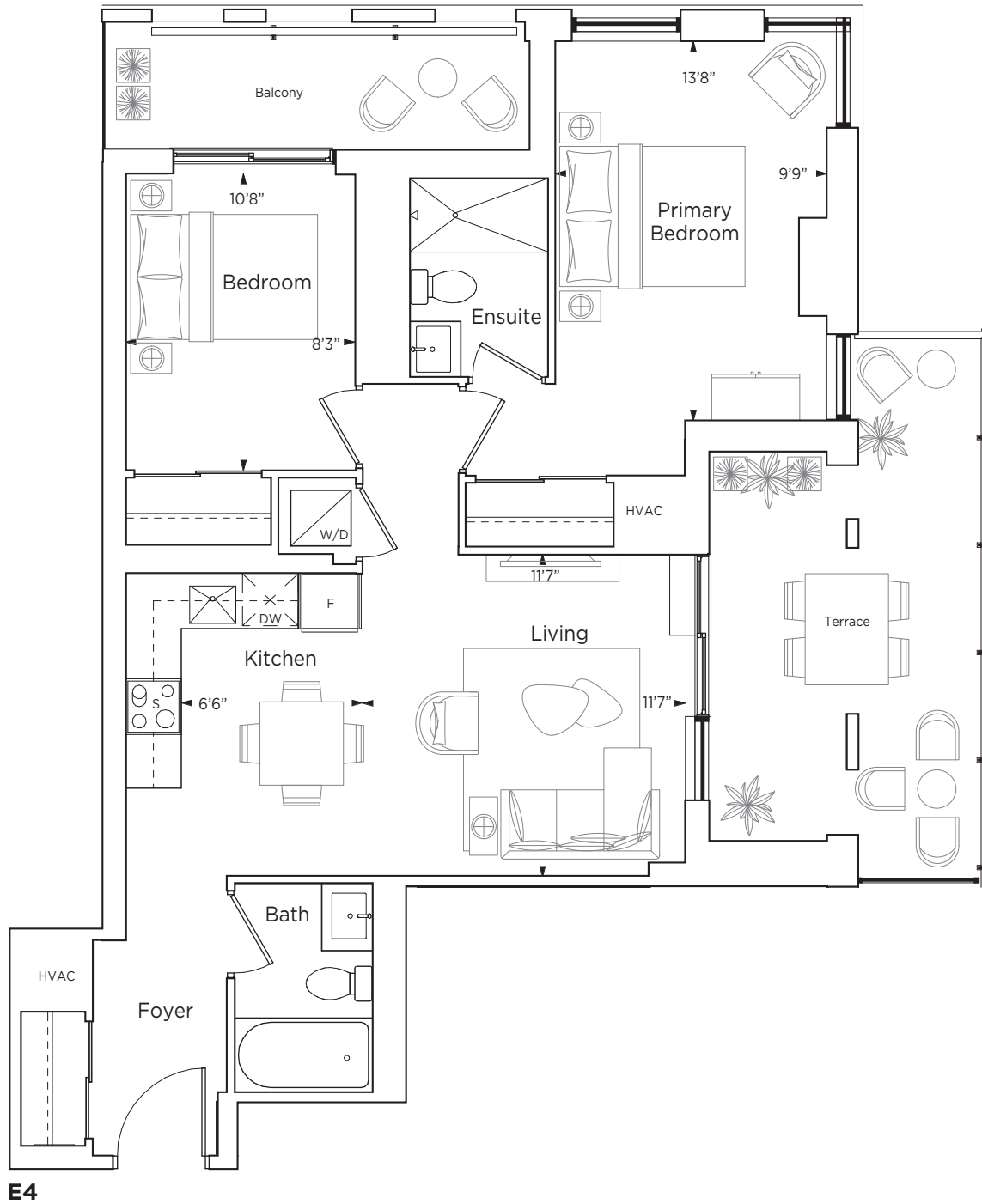

Vincent
CONDOMINIUMS



Tower A
LEVEL 5

Materials, specifications and floor plans are subject to change. All renderings are artist's concept. All floor plans are approximate dimensions. Actual usable floor space may vary from stated floor area. Balcony/terrace areas may vary. Windows, room/area dimensions & square feet may vary due to location within building. Furniture not included. E. & O. E.

TWO BED

TWEED

855 SQ.FT. • 92 SQ.FT. BALCONY

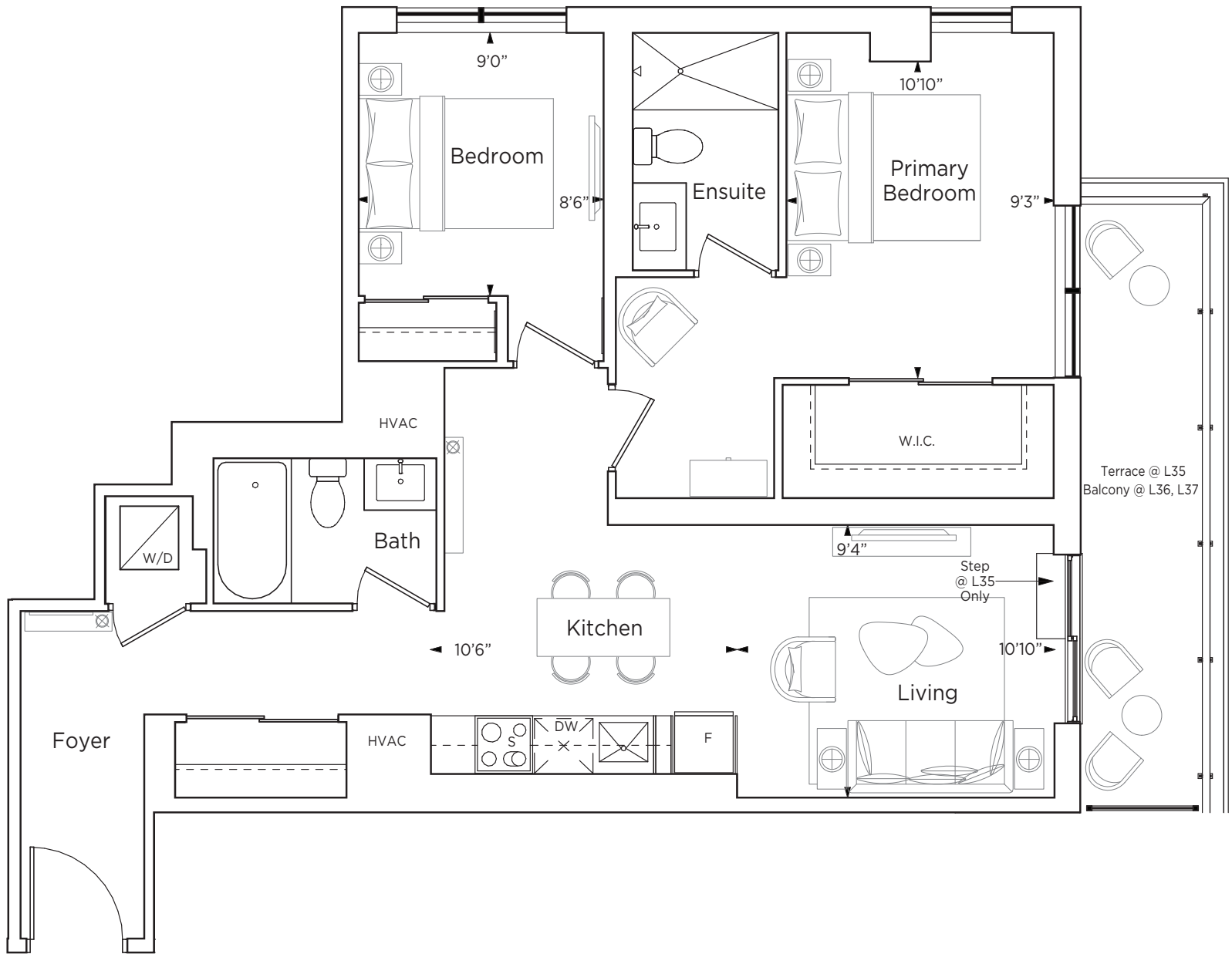

M7



Vincent
CONDOMINIUMS

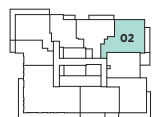

Tower A
LEVEL 35 - 37

Materials, specifications and floor plans are subject to change. All renderings are artist's concept. All floor plans are approximate dimensions. Actual usable floor space may vary from stated floor area. Balcony/terrace areas may vary. Windows, room/area dimensions & square feet may vary due to location within building. Furniture not included. E. & O. E.

THREE BED (BARRIER-FREE)

VIENNA

1489 SQ.FT. • 228 SQ.FT. BALCONY • 241 SQ.FT. TERRACE

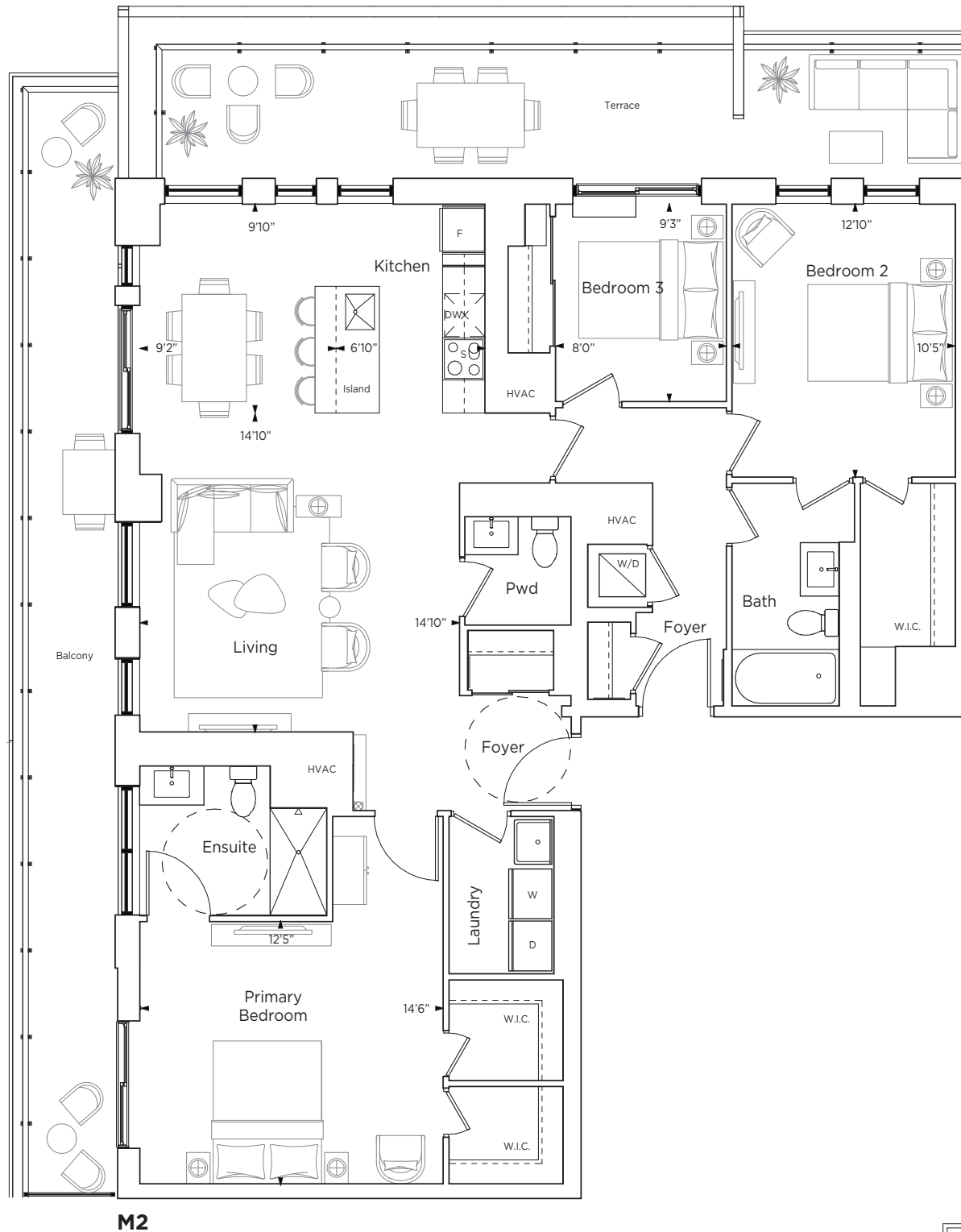

Vincent
CONDOMINIUMS



Tower A
LEVEL 35

Materials, specifications and floor plans are subject to change. All renderings are artist's concept. All floor plans are approximate dimensions. Actual usable floor space may vary from stated floor area. Balcony/terrace areas may vary. Windows, room/area dimensions & square feet may vary due to location within building. Furniture not included. E. & O. E.

THREE BED

VINCENT

1489 SQ.FT. • 353 SQ.FT. BALCONY

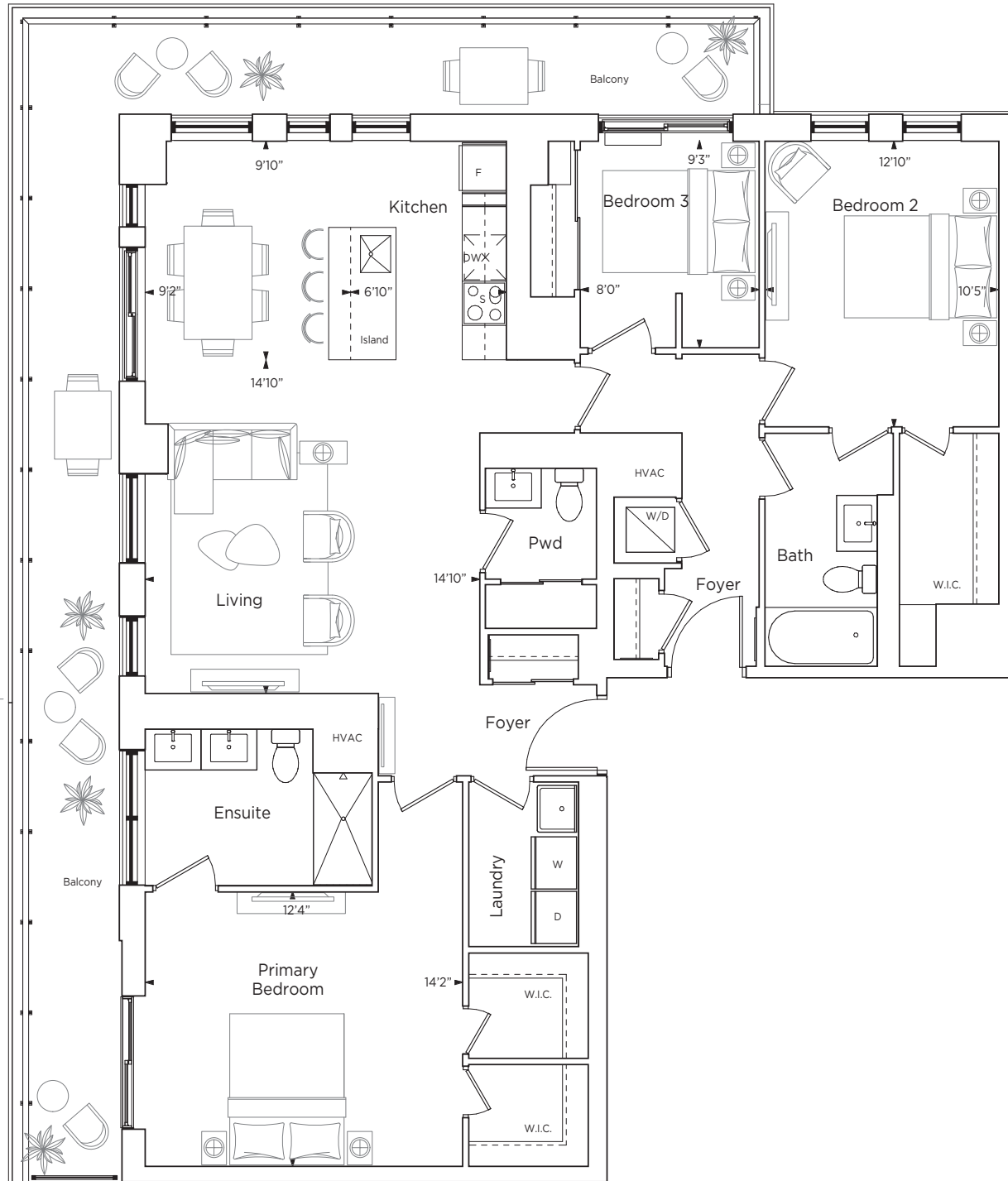

M3



Vincent
CONDOMINIUMS

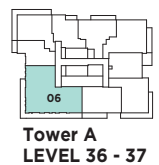

Materials, specifications and floor plans are subject to change. All renderings are artist's concept. All floor plans are approximate dimensions. Actual usable floor space may vary from stated floor area. Balcony/terrace areas may vary. Windows, room/area dimensions & square feet may vary due to location within building. Furniture not included. E. & O. E.

TWO BED

SILVER CLOUD

816 SQ.FT. • 65 SQ.FT. BALCONY • 167 SQ.FT. TERRACE

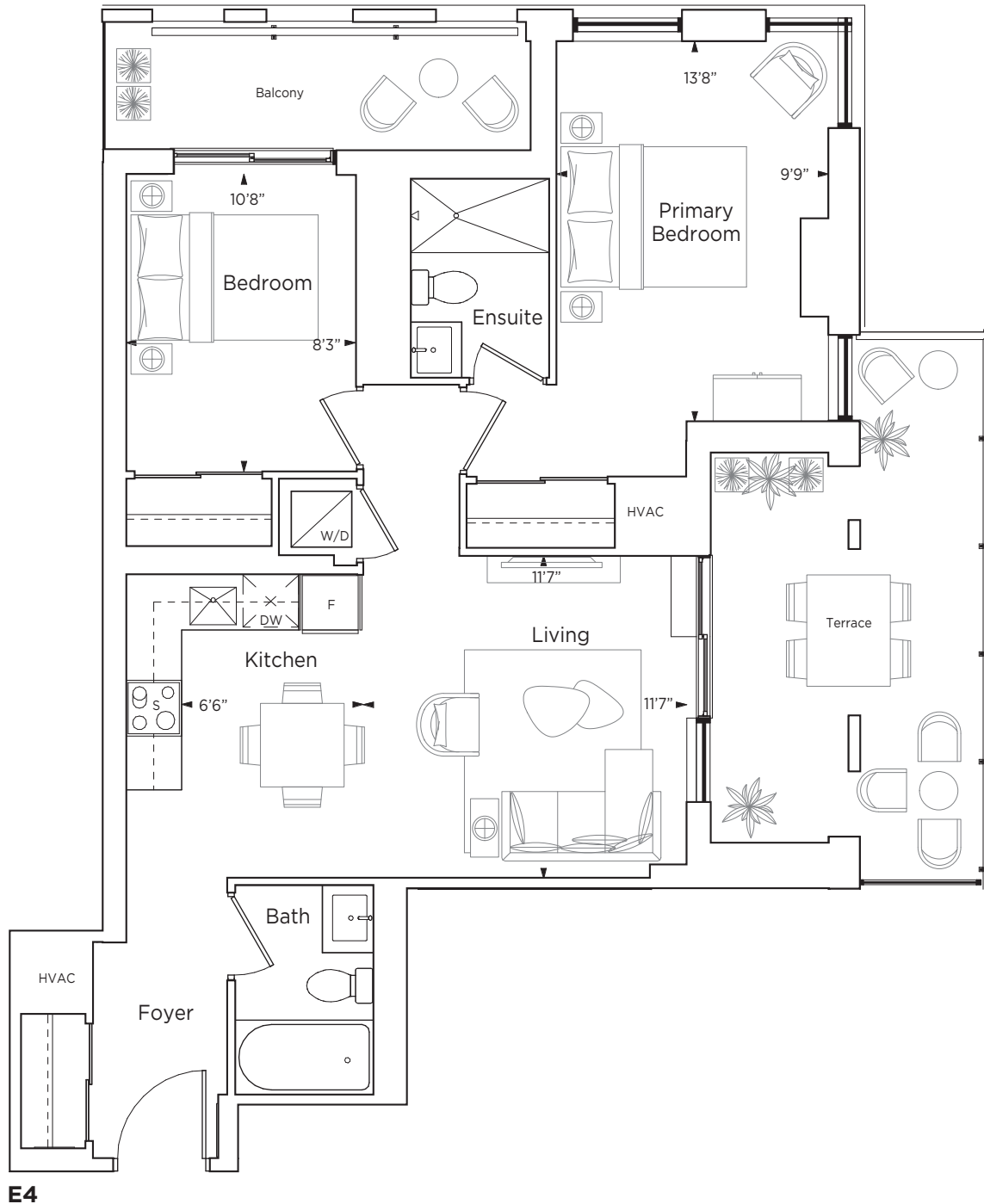

Vincent
CONDOMINIUMS



Tower A
LEVEL 5

Materials, specifications and floor plans are subject to change. All renderings are artist's concept. All floor plans are approximate dimensions. Actual usable floor space may vary from stated floor area. Balcony/terrace areas may vary. Windows, room/area dimensions & square feet may vary due to location within building. Furniture not included. E. & O. E.

TWO BED

TWEED

855 SQ.FT. • 92 SQ.FT. BALCONY

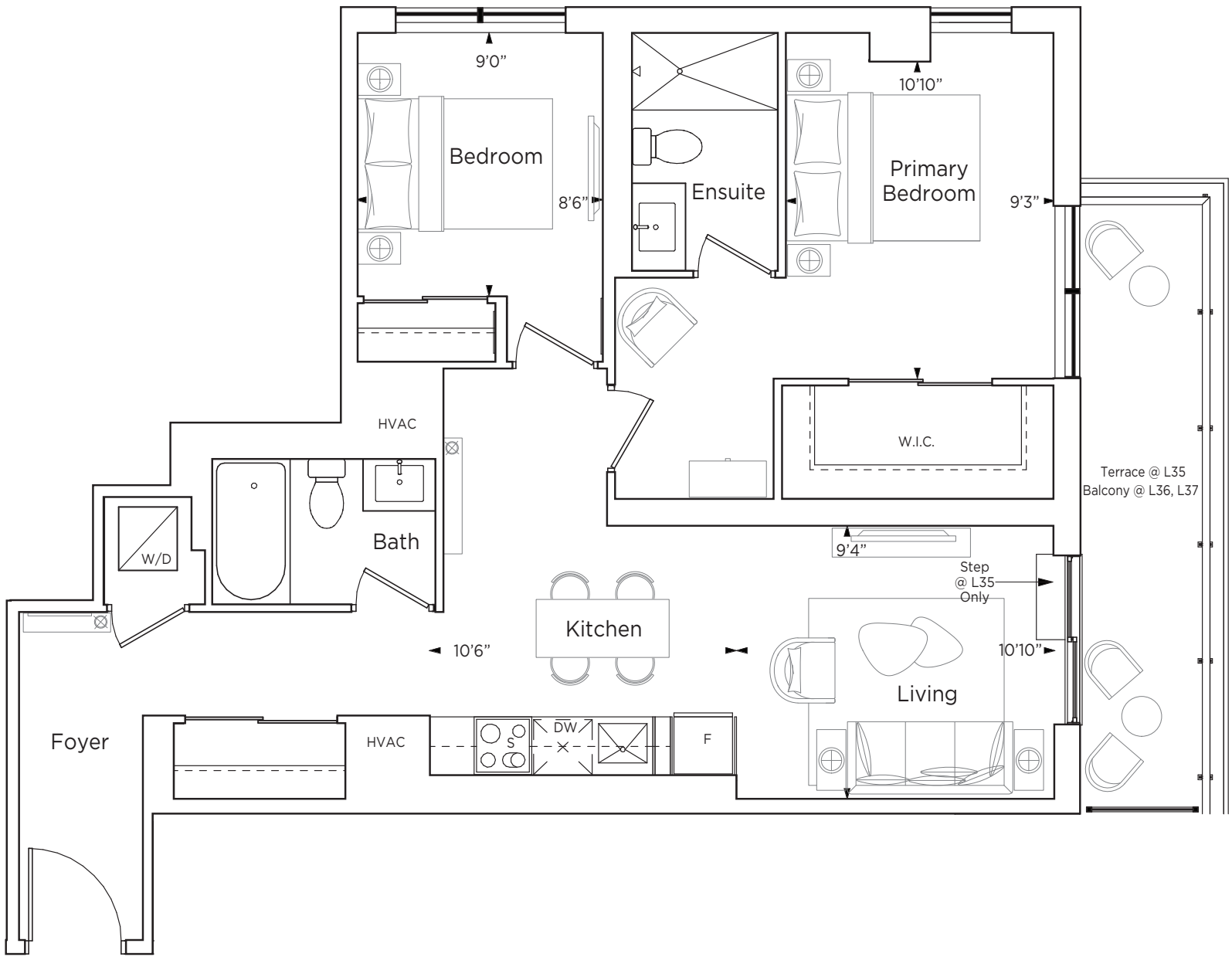

M7



Vincent
CONDOMINIUMS

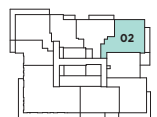

Tower A
LEVEL 35 - 37

Materials, specifications and floor plans are subject to change. All renderings are artist's concept. All floor plans are approximate dimensions. Actual usable floor space may vary from stated floor area. Balcony/terrace areas may vary. Windows, room/area dimensions & square feet may vary due to location within building. Furniture not included. E. & O. E.

THREE BED (BARRIER-FREE)

VIENNA

1489 SQ.FT. • 228 SQ.FT. BALCONY • 241 SQ.FT. TERRACE

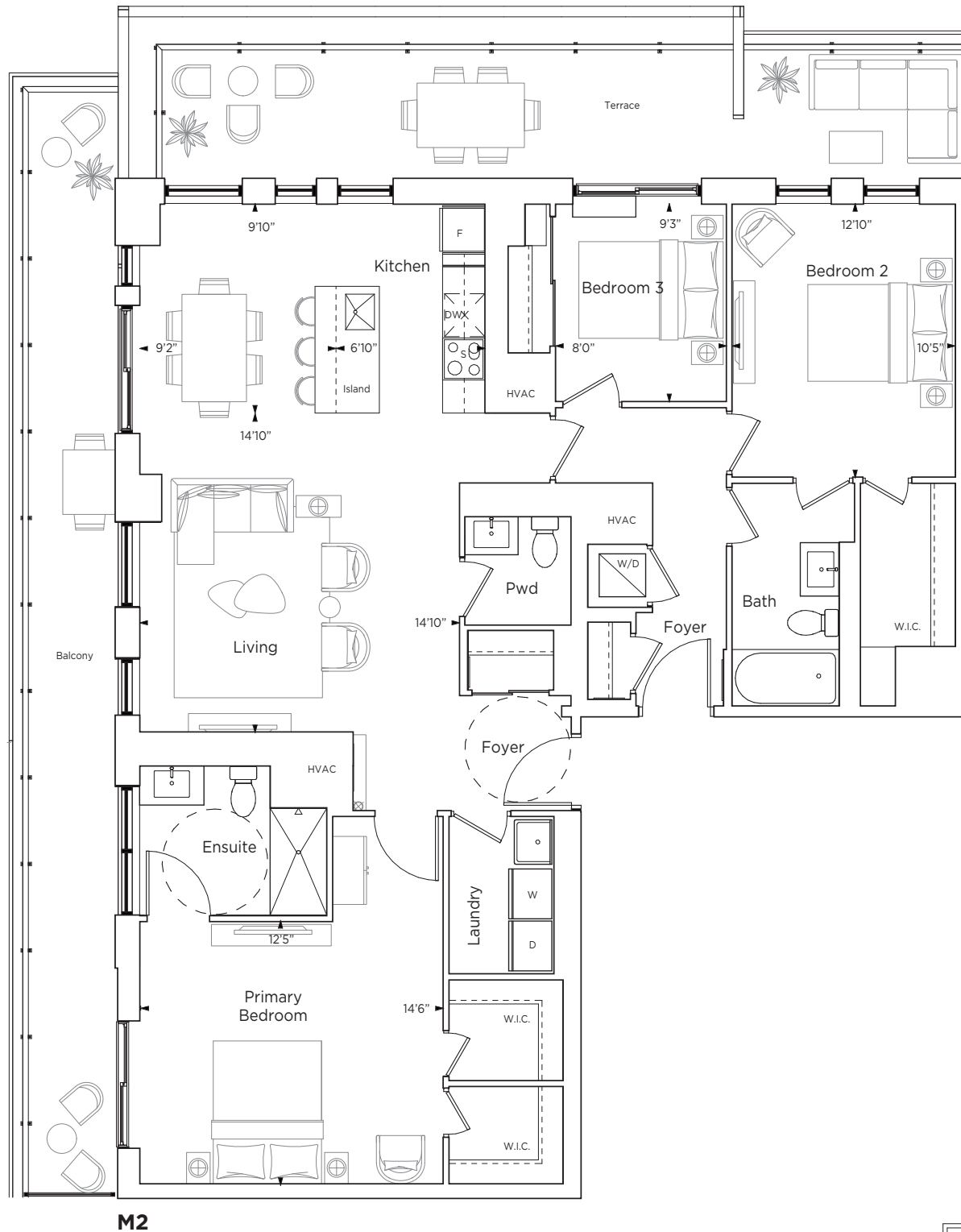

Vincent
CONDOMINIUMS

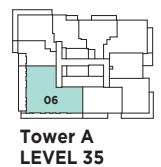

Materials, specifications and floor plans are subject to change. All renderings are artist's concept. All floor plans are approximate dimensions. Actual usable floor space may vary from stated floor area. Balcony/terrace areas may vary. Windows, room/area dimensions & square feet may vary due to location within building. Furniture not included. E. & O. E.

THREE BED

VINCENT

1489 SQ.FT. • 353 SQ.FT. BALCONY

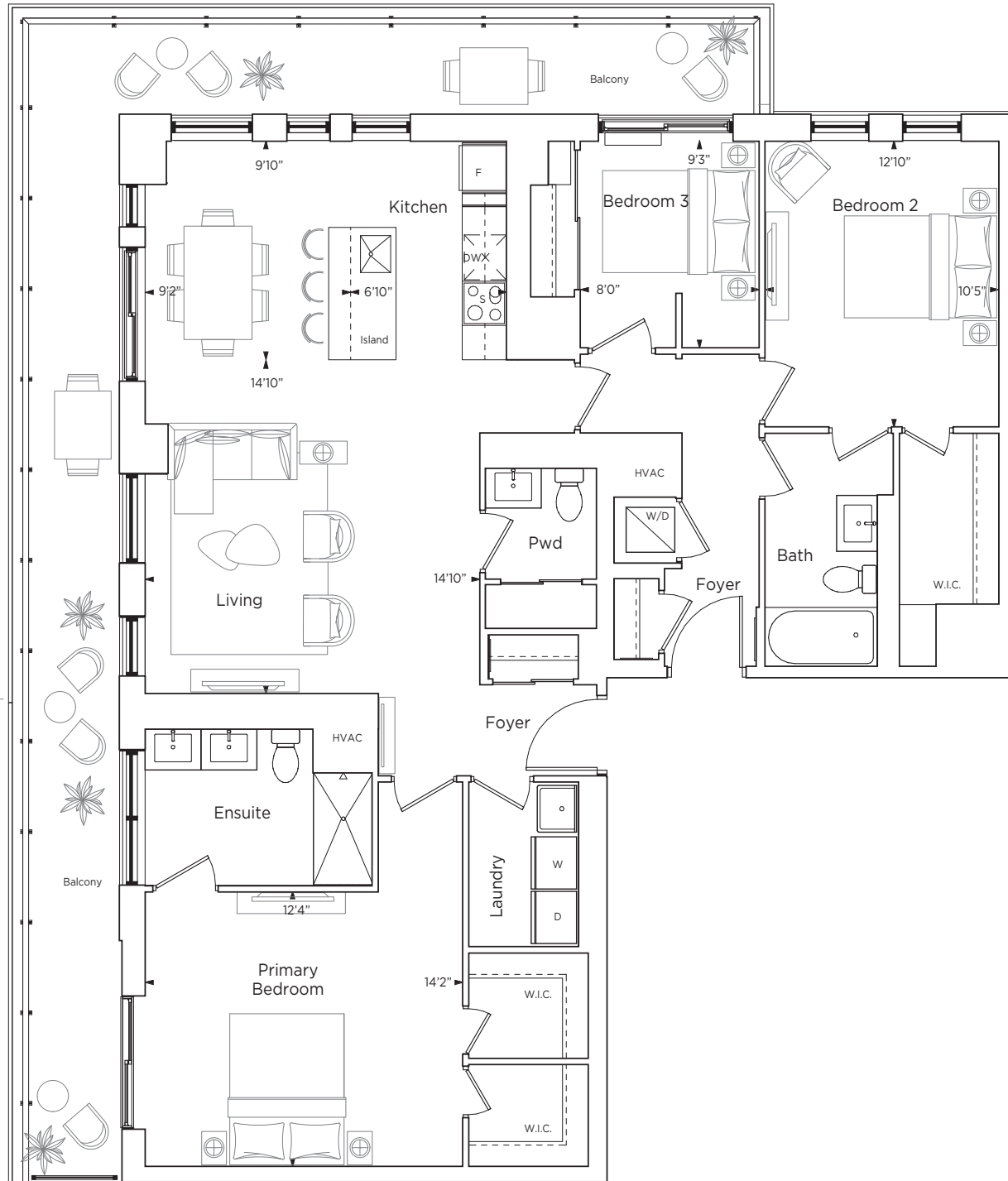

M3



Vincent
CONDOMINIUMS

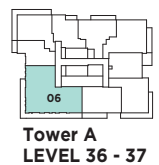

Materials, specifications and floor plans are subject to change. All renderings are artist's concept. All floor plans are approximate dimensions. Actual usable floor space may vary from stated floor area. Balcony/terrace areas may vary. Windows, room/area dimensions & square feet may vary due to location within building. Furniture not included. E. & O. E.