

Exterior, windows, colours, grading, landscaping, garage and entrance doors may vary from the renderings. Furniture is displayed for illustration purposes only and does not necessarily reflect the electrical plan for the unit. Units are sold unfurnished. Materials, sizes and specifications are subject to change without notice. Orientation of suite may be reversed and purchaser agrees to accept same. Exterior colours, grading, landscaping, garage and entrance doors may vary from the renderings. All Schedule Ys attached to the legal agreement of purchase and sale supersede artist's renderings. The dimensions shown on this plan are approximate only. Actual useable floor space within the unit may vary from any stated floor areas or dimensions on this plan. For more information on the method used for calculating the floor area of any unit, reference should be made to Builder Bulletin No. 22 published by Tarion, E. & O.E. March 2021.

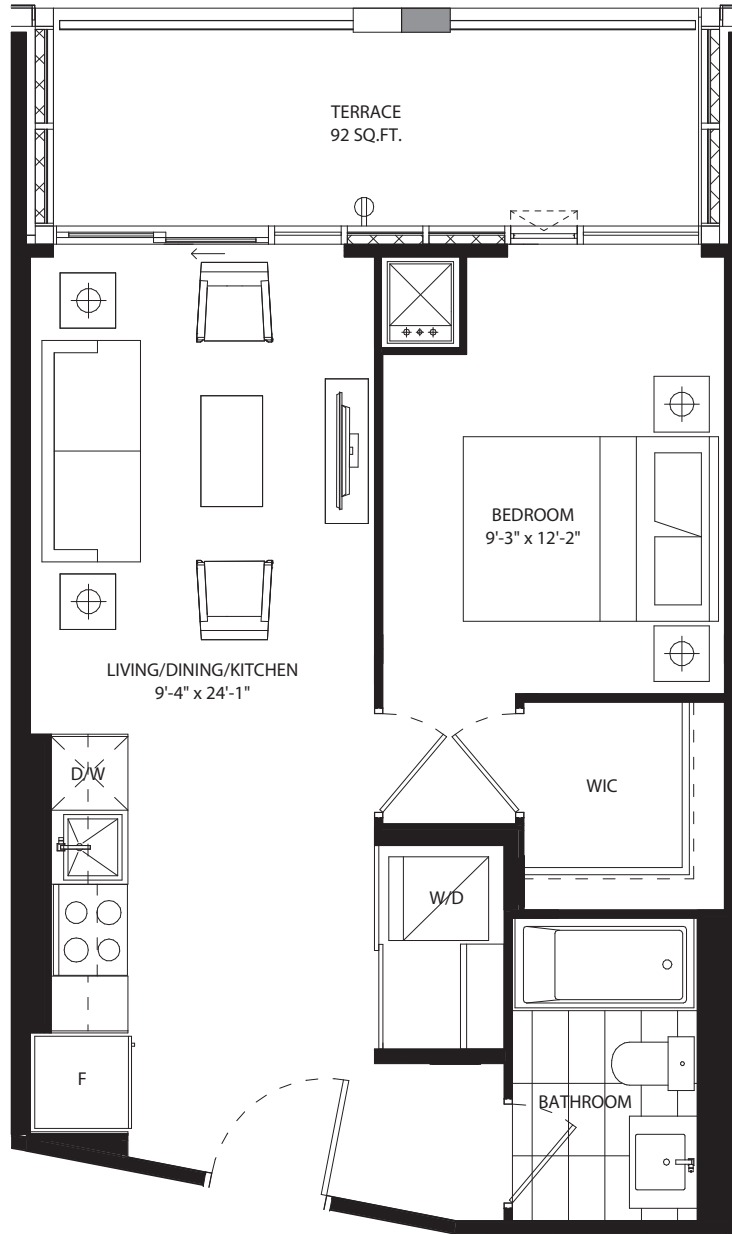

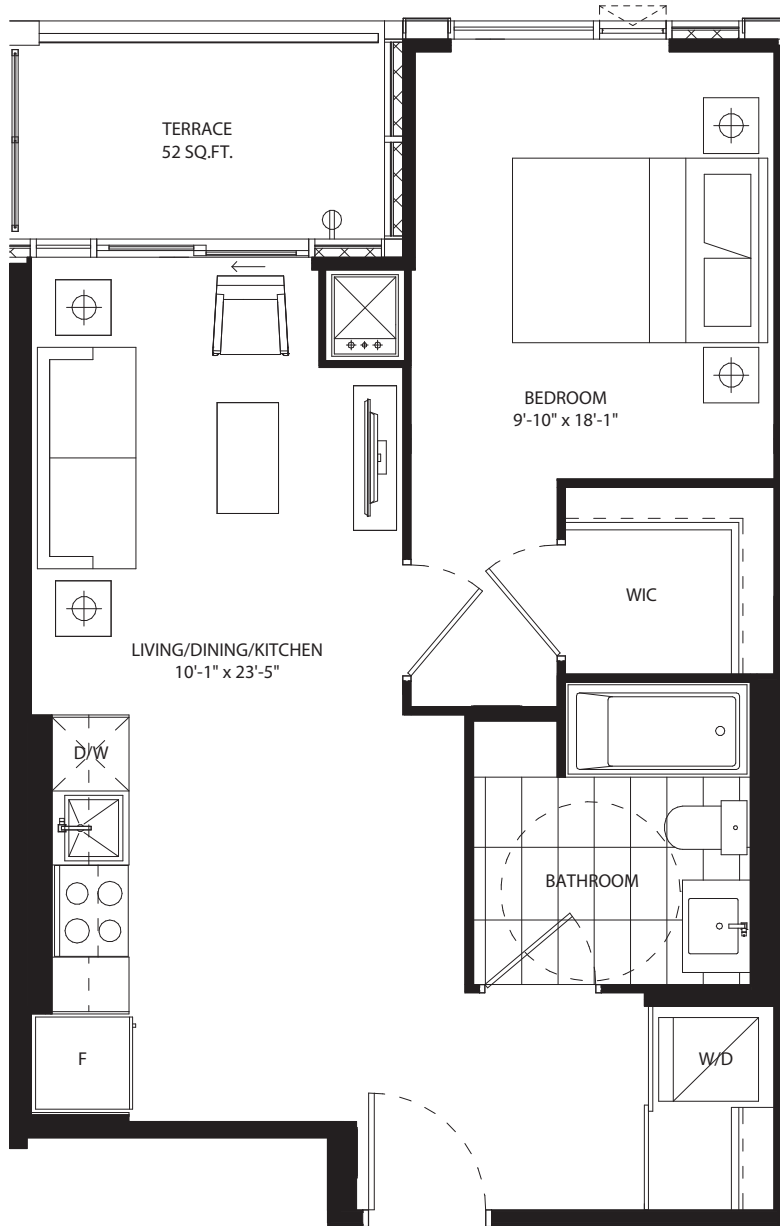

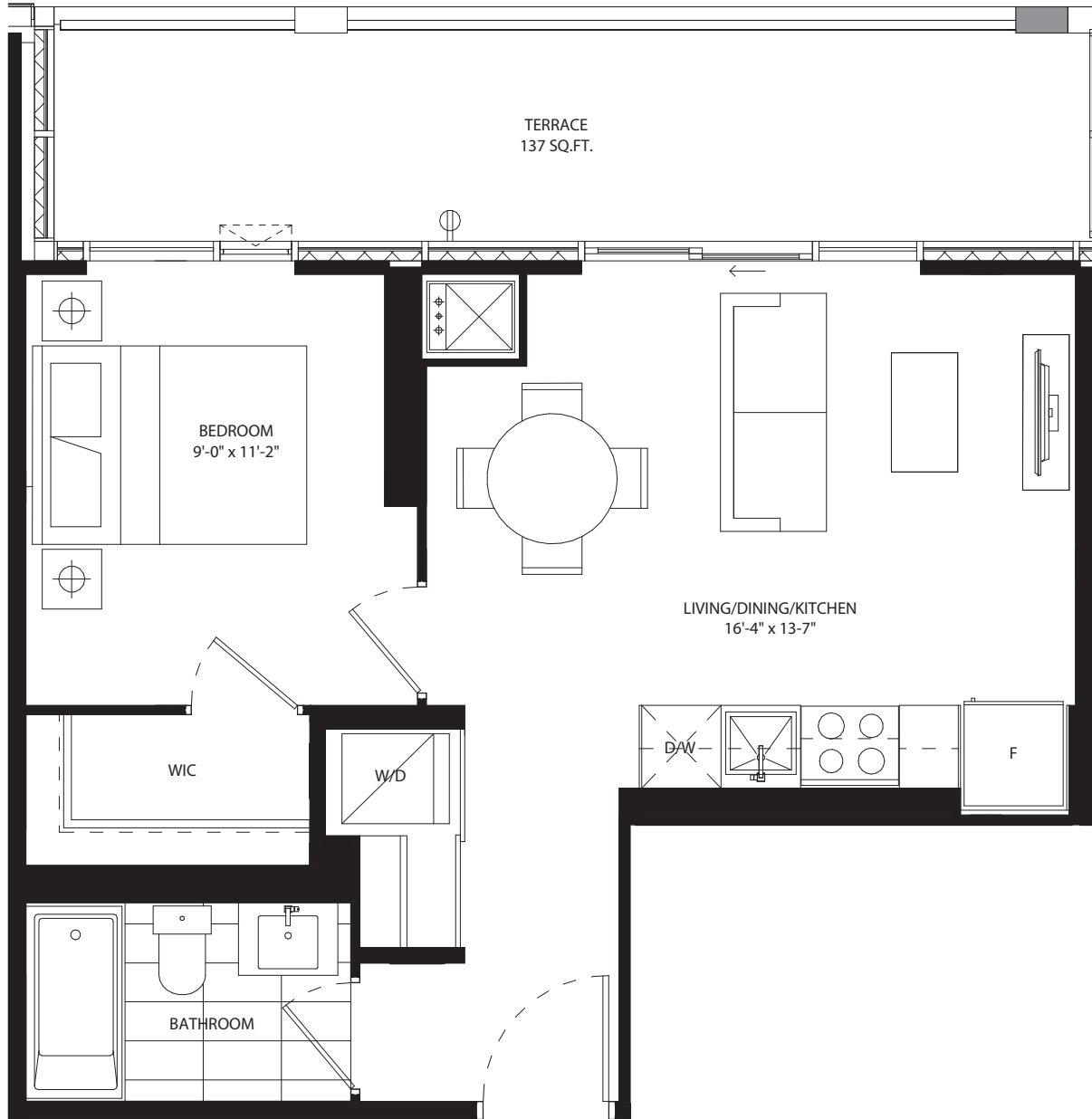

Exterior, windows, colours, grading, landscaping, garage and entrance doors may vary from the renderings. Furniture is displayed for illustration purposes only and does not necessarily reflect the electrical plan for the unit. Units are sold unfurnished. Materials, sizes and specifications are subject to change without notice. Orientation of suite may be reversed and purchaser agrees to accept same. Exterior colours, grading, landscaping, garage and entrance doors may vary from the renderings. All Schedule Ys attached to the legal agreement of purchase and sale supersede artist's renderings. The dimensions shown on this plan are approximate only. Actual useable floor space within the unit may vary from any stated floor areas or dimensions on this plan. For more information on the method used for calculating the floor area of any unit, reference should be made to Builder Bulletin No. 22 published by Tarion, E. & O.E. March 2021.



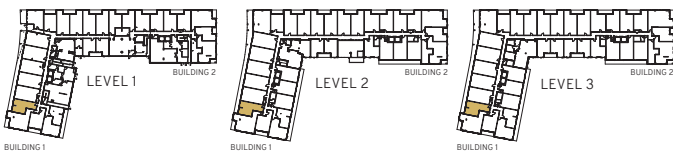
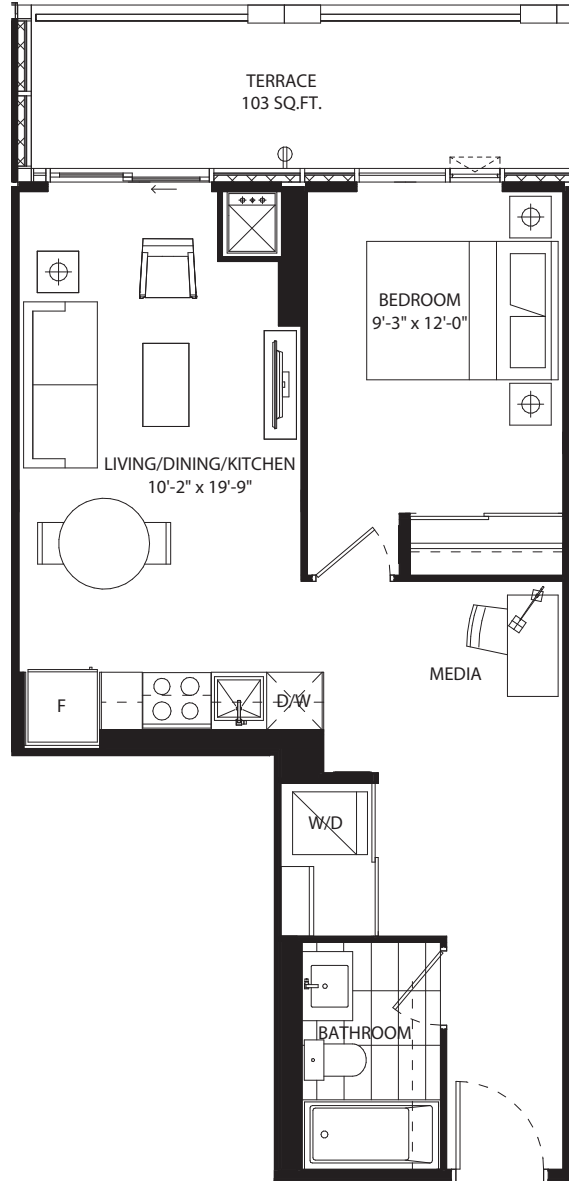



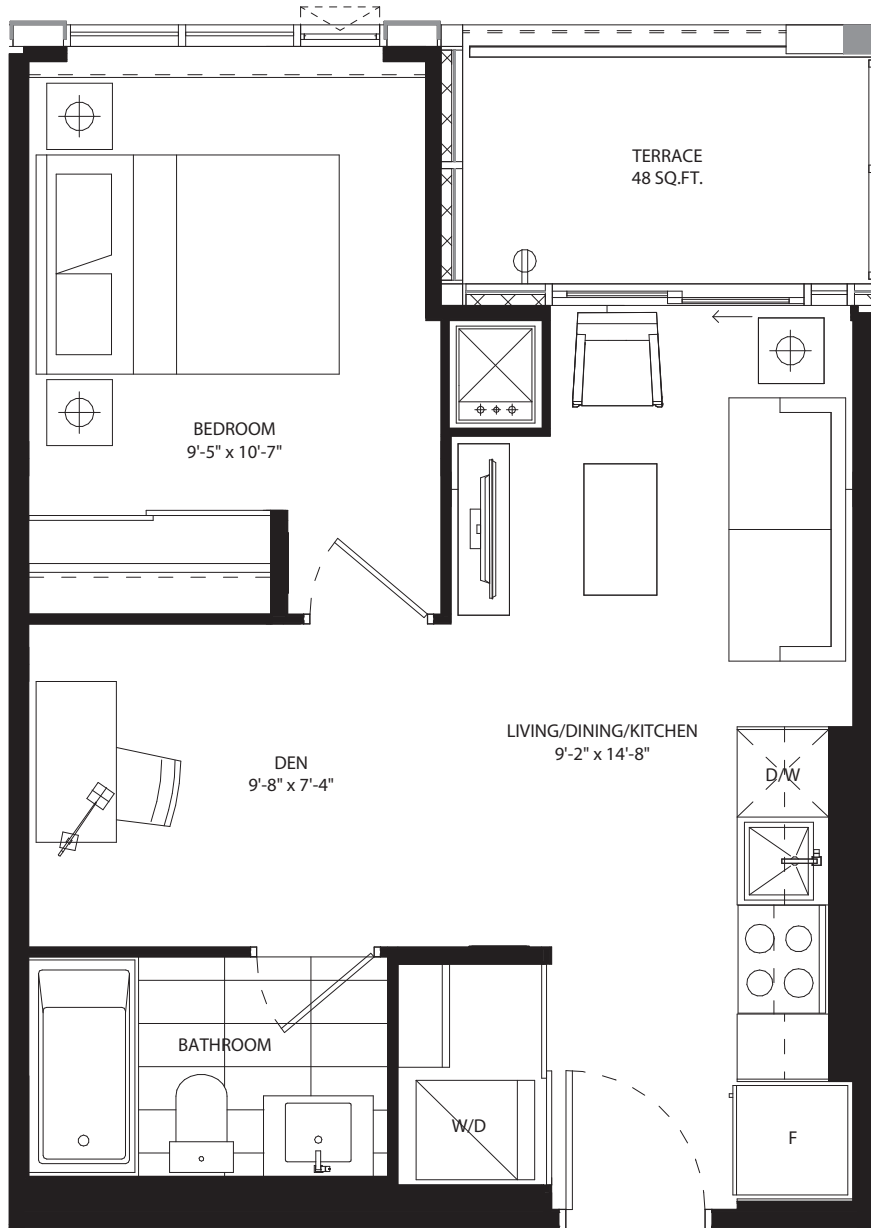

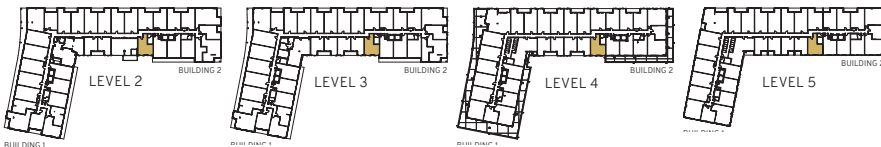
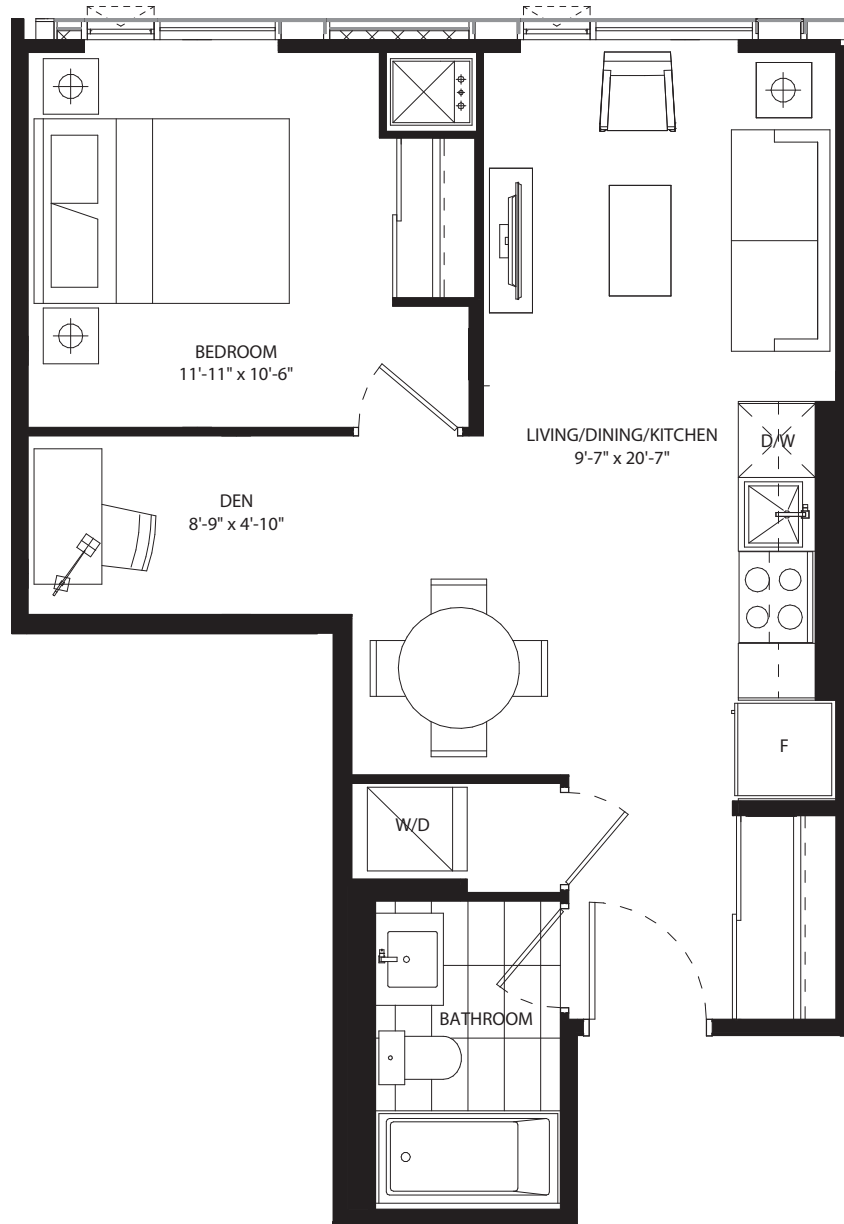

1 bedroom + den  
591 SF

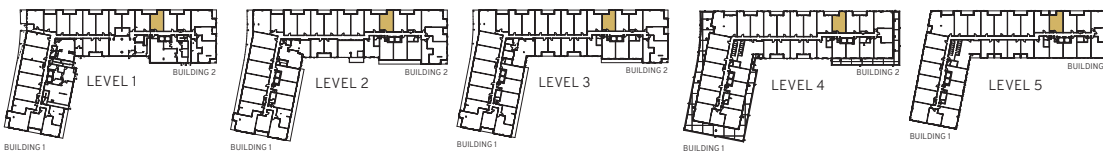
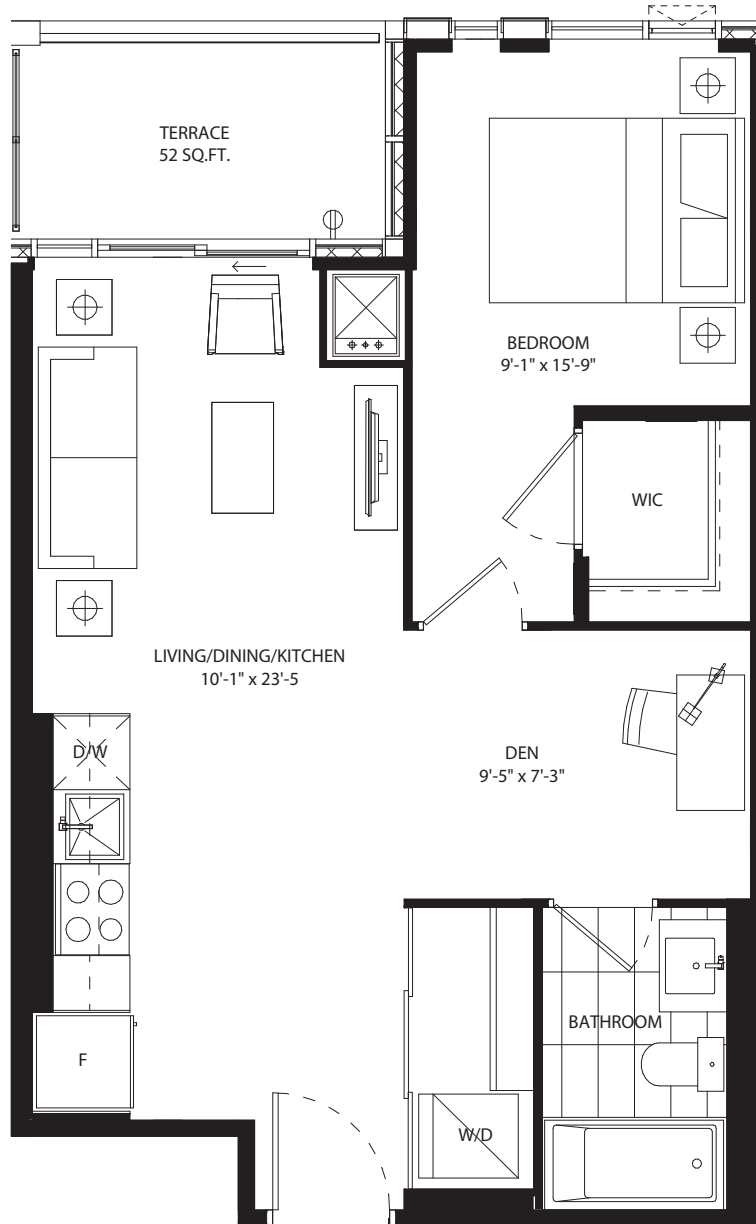

Exterior, windows, colours, grading, landscaping, garage and entrance doors may vary from the renderings. Furniture is displayed for illustration purposes only and does not necessarily reflect the electrical plan for the unit. Units are sold unfurnished. Materials, sizes and specifications are subject to change without notice. Orientation of suite may be reversed and purchaser agrees to accept same. Exterior colours, grading, landscaping, garage and entrance doors may vary from the renderings. All Schedule Ys attached to the legal agreement of purchase and sale supersede artist's renderings. The dimensions shown on this plan are approximate only. Actual useable floor space within the unit may vary from any stated floor areas or dimensions on this plan. For more information on the method used for calculating the floor area of any unit, reference should be made to Builder Bulletin No. 22 published by Tarion, E. & O.E. March 2021.



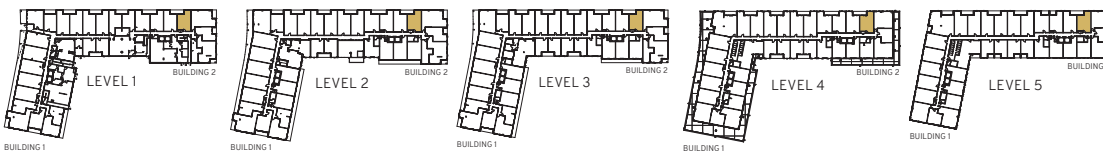
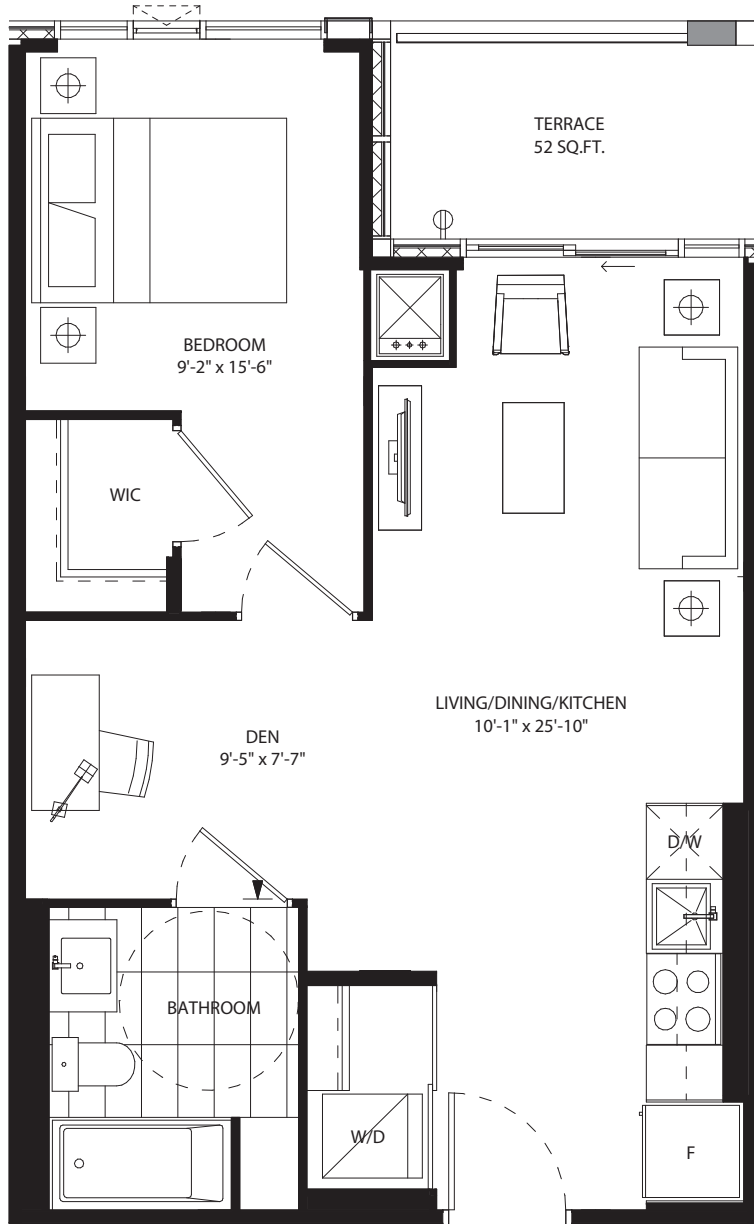

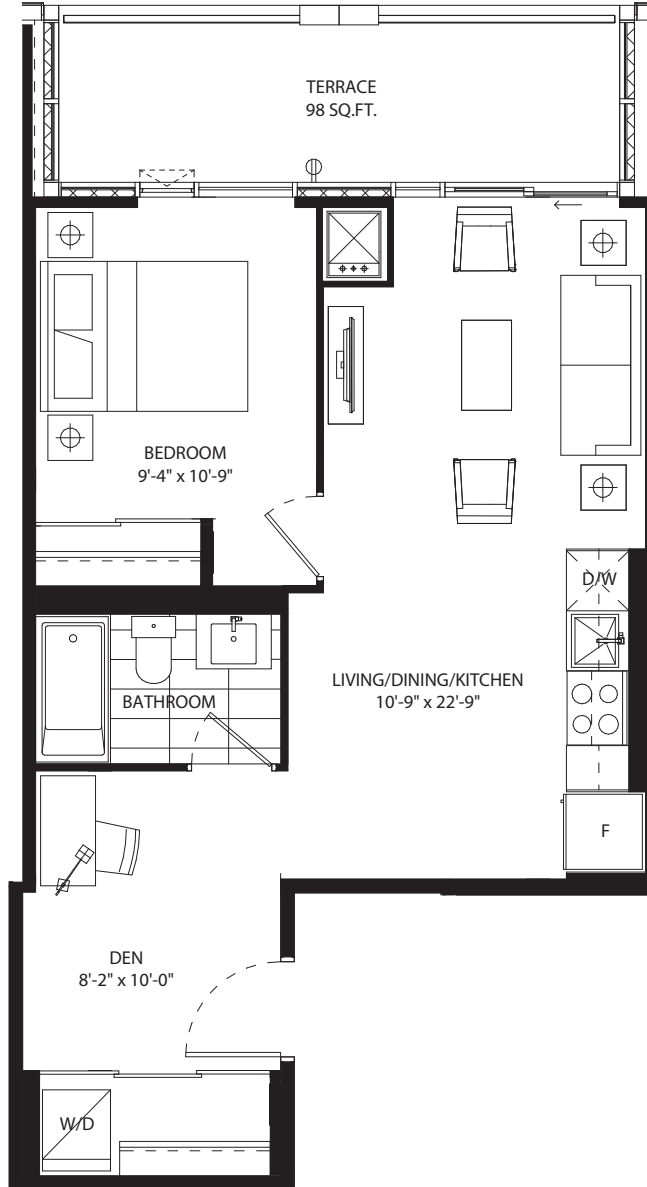

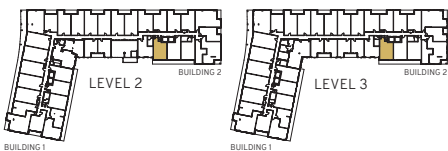
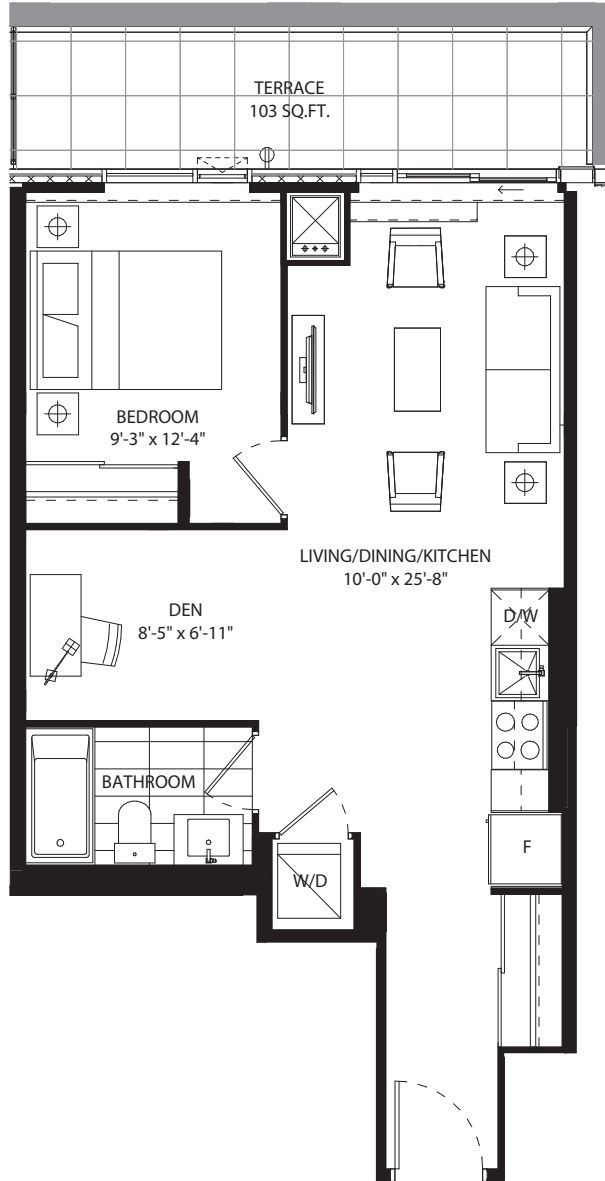

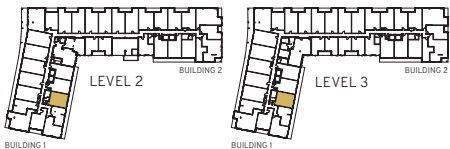
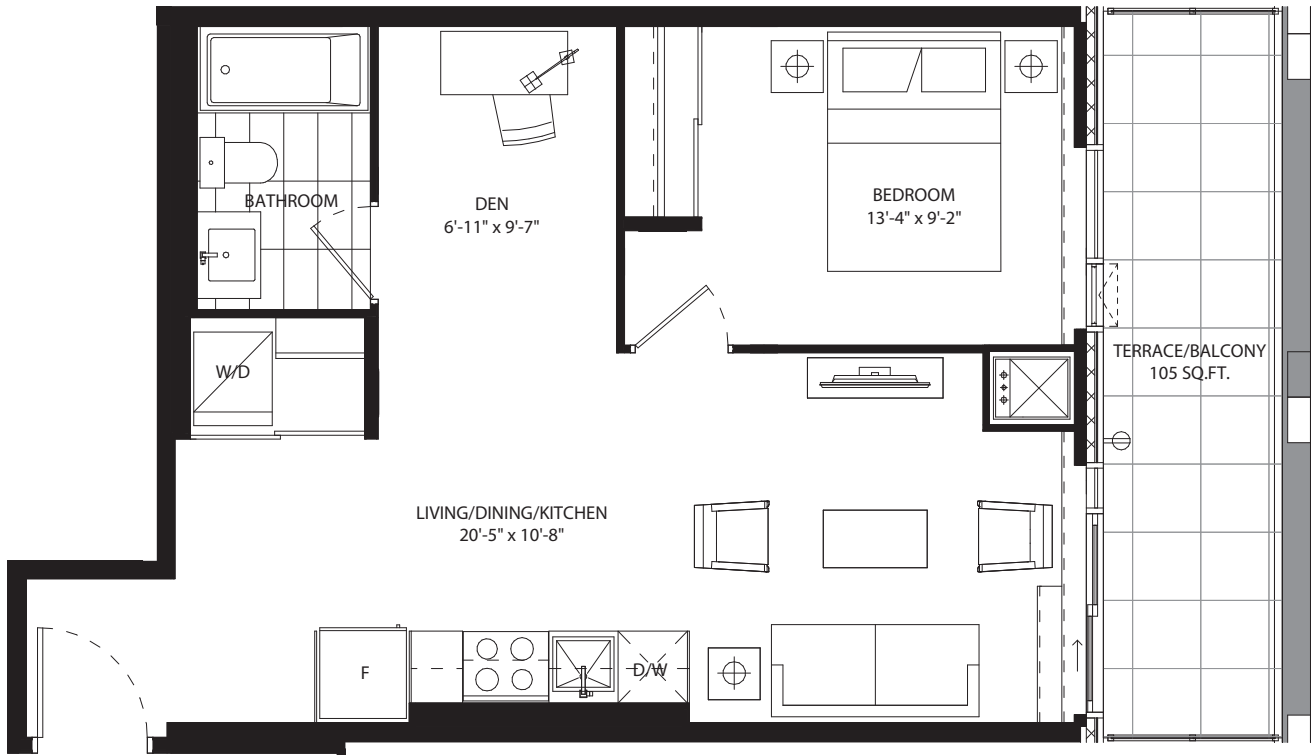

Exterior, windows, colours, grading, landscaping, garage and entrance doors may vary from the renderings. Furniture is displayed for illustration purposes only and does not necessarily reflect the electrical plan for the unit. Units are sold unfurnished. Materials, sizes and specifications are subject to change without notice. Orientation of suite may be reversed and purchaser agrees to accept same. Exterior colours, grading, landscaping, garage and entrance doors may vary from the renderings. All Schedule Ys attached to the legal agreement of purchase and sale supersede artist's renderings. The dimensions shown on this plan are approximate only. Actual useable floor space within the unit may vary from any stated floor areas or dimensions on this plan. For more information on the method used for calculating the floor area of any unit, reference should be made to Builder Bulletin No. 22 published by Tarion, E. & O.E. March 2021.

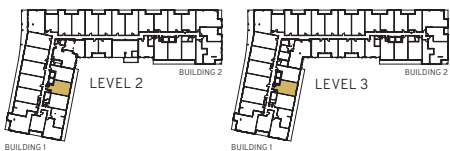
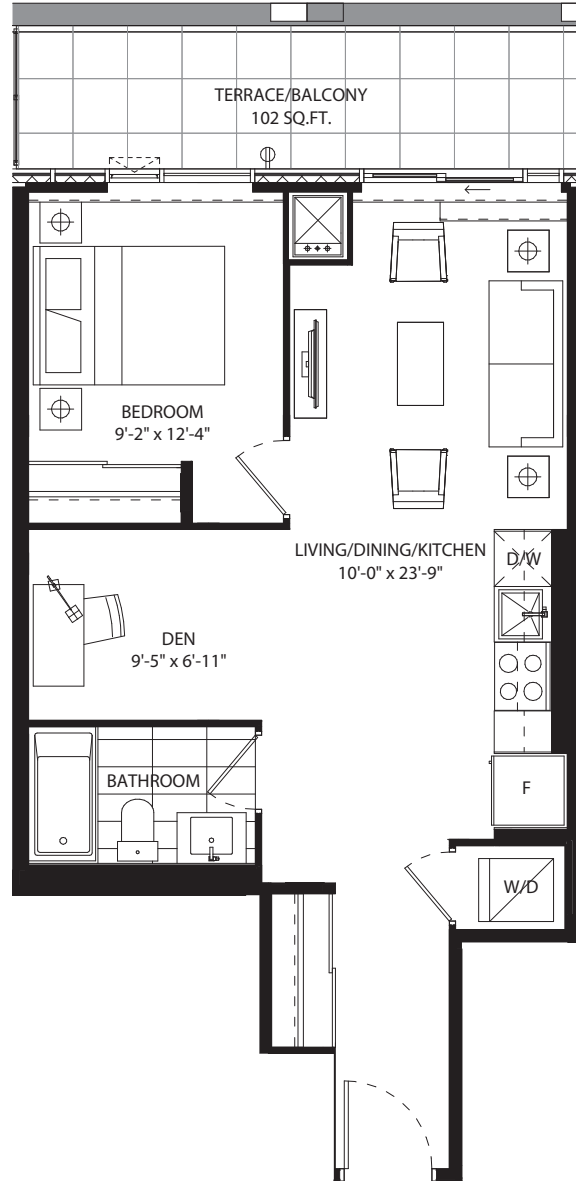

Exterior, windows, colours, grading, landscaping, garage and entrance doors may vary from the renderings. Furniture is displayed for illustration purposes only and does not necessarily reflect the electrical plan for the unit. Units are sold unfurnished. Materials, sizes and specifications are subject to change without notice. Orientation of suite may be reversed and purchaser agrees to accept same. Exterior colours, grading, landscaping, garage and entrance doors may vary from the renderings. All Schedule Ys attached to the legal agreement of purchase and sale supersede artist's renderings. The dimensions shown on this plan are approximate only. Actual useable floor space within the unit may vary from any stated floor areas or dimensions on this plan. For more information on the method used for calculating the floor area of any unit, reference should be made to Builder Bulletin No. 22 published by Tarion, E. & O.E. March 2021.



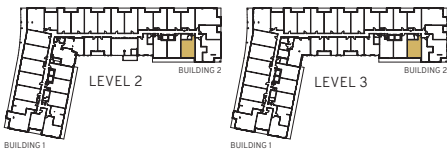
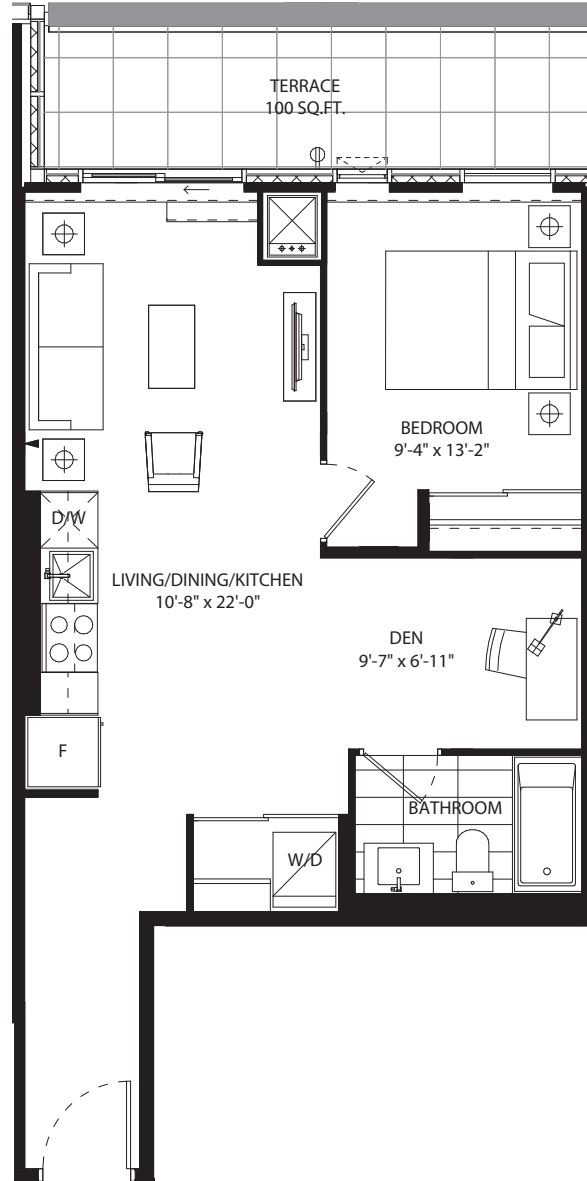

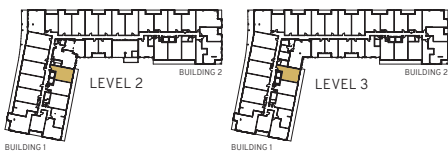
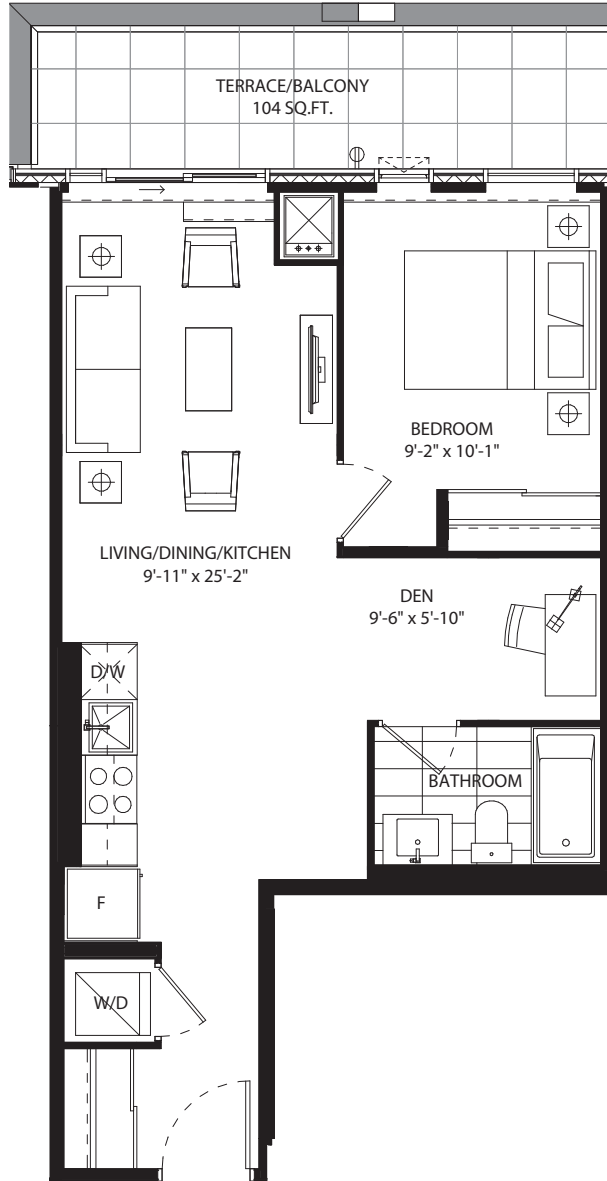

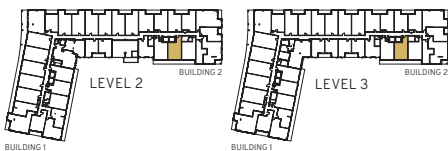
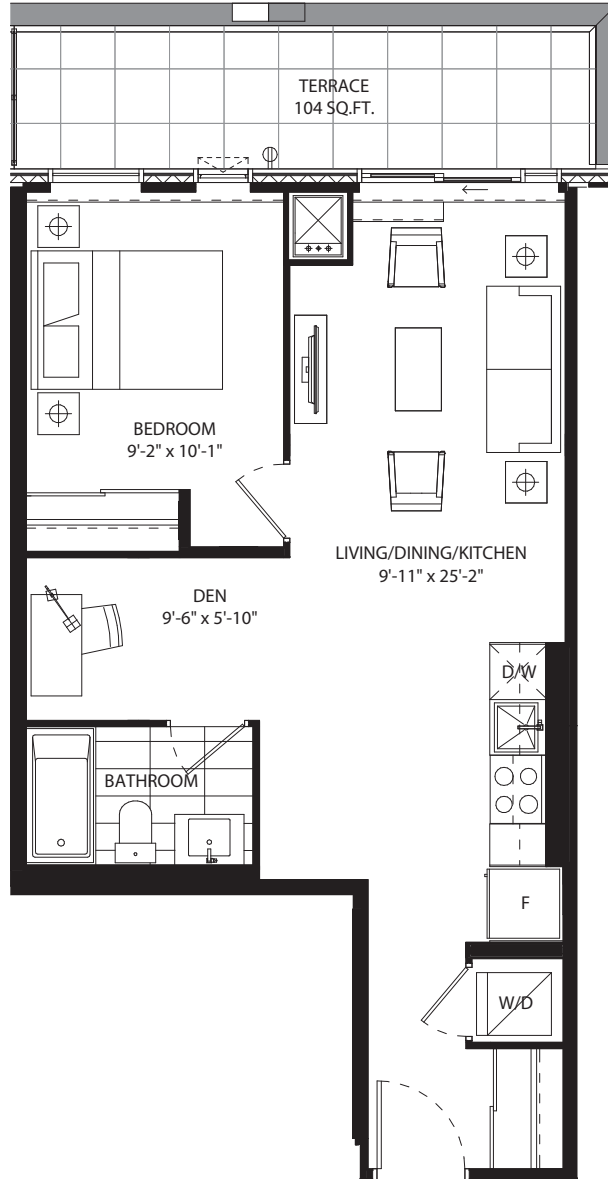



Exterior, windows, colours, grading, landscaping, garage and entrance doors may vary from the renderings. Furniture is displayed for illustration purposes only and does not necessarily reflect the electrical plan for the unit. Units are sold unfurnished. Materials, sizes and specifications are subject to change without notice. Orientation of suite may be reversed and purchaser agrees to accept same. Exterior colours, grading, landscaping, garage and entrance doors may vary from the renderings. All Schedule Ys attached to the legal agreement of purchase and sale supersede artist's renderings. The dimensions shown on this plan are approximate only. Actual useable floor space within the unit may vary from any stated floor areas or dimensions on this plan. For more information on the method used for calculating the floor area of any unit, reference should be made to Builder Bulletin No. 22 published by Tarion, E. & O.E. March 2021.



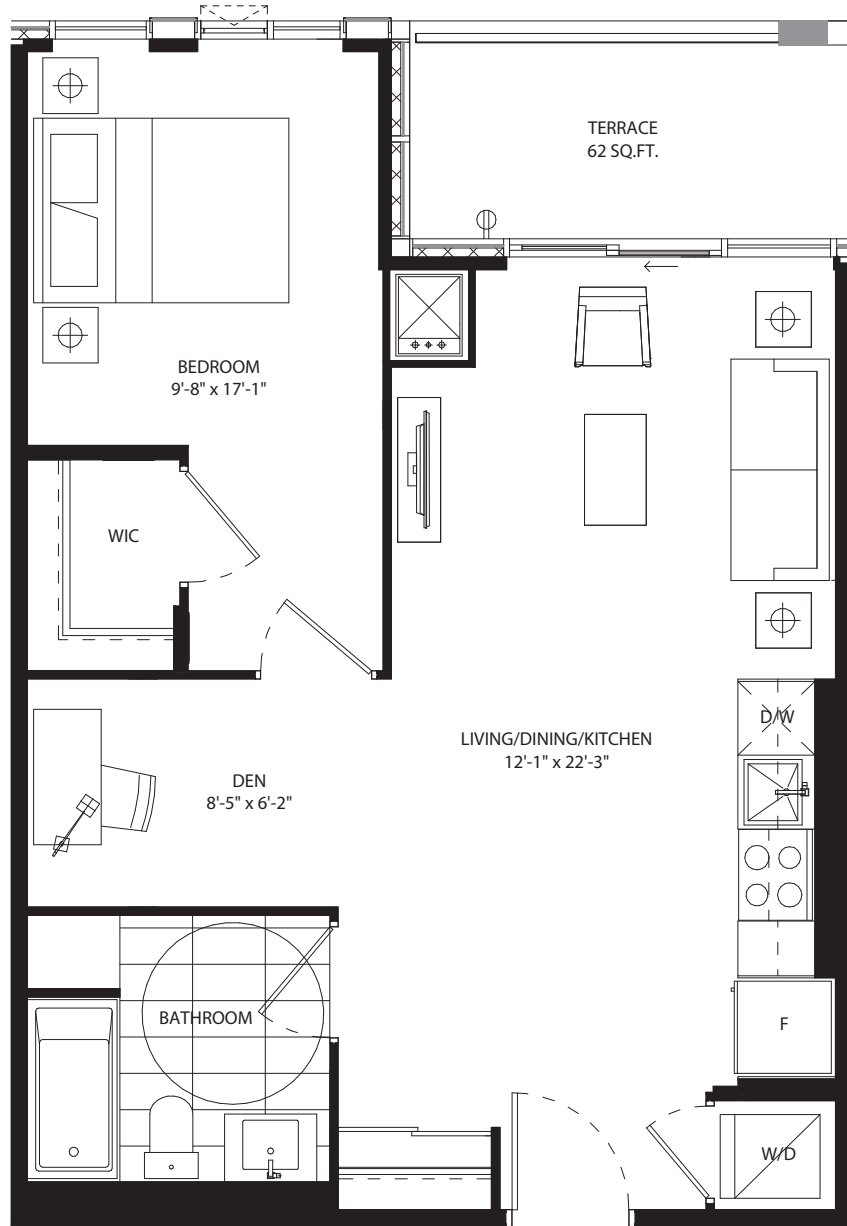

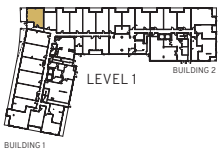
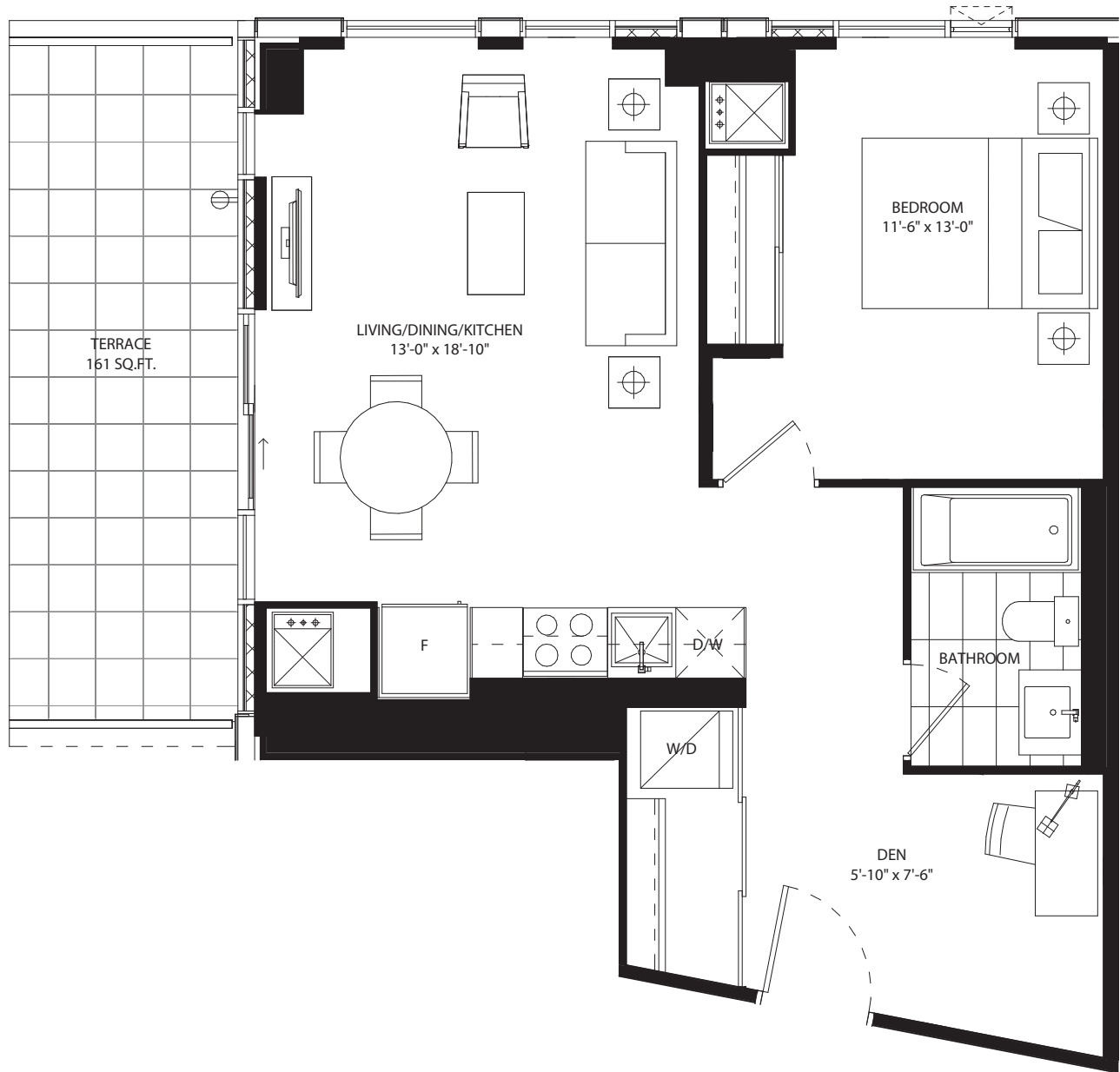

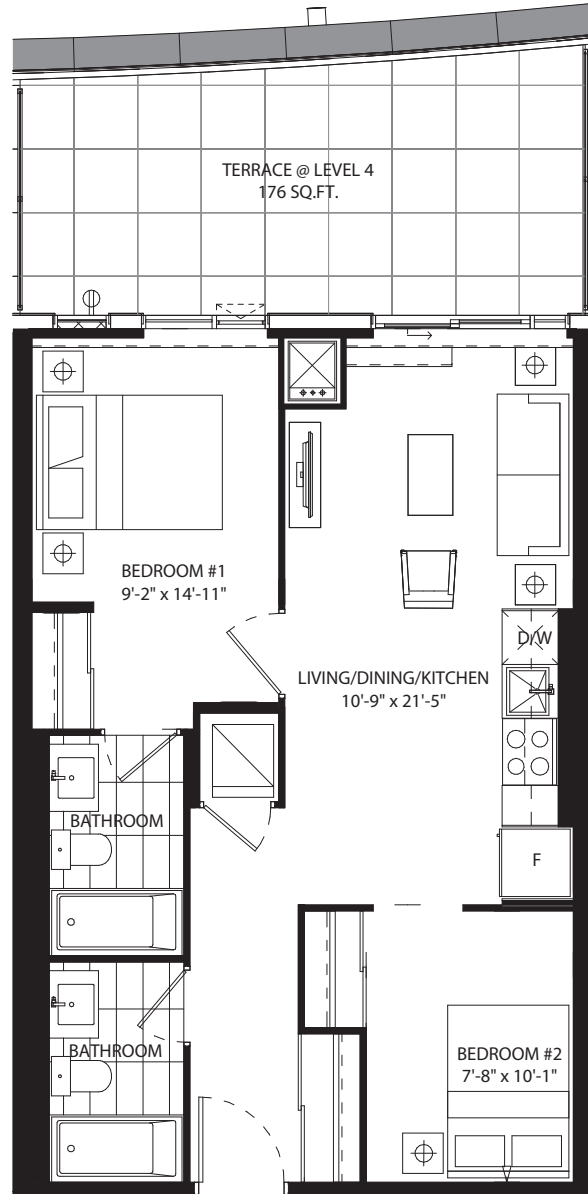
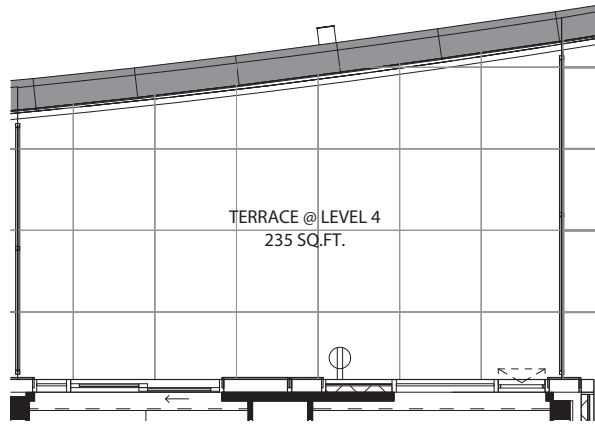

NO BALCONY AT LEVEL 5

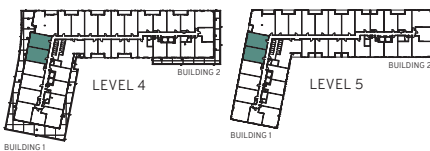

Exterior, windows, colours, grading, landscaping, garage and entrance doors may vary from the renderings. Furniture is displayed for illustration purposes only and does not necessarily reflect the electrical plan for the unit. Units are sold unfurnished. Materials, sizes and specifications are subject to change without notice. Orientation of suite may be reversed and purchaser agrees to accept same. Exterior colours, grading, landscaping, garage and entrance doors may vary from the renderings. All Schedule Ys attached to the legal agreement of purchase and sale supersede artist's renderings. The dimensions shown on this plan are approximate only. Actual useable floor space within the unit may vary from any stated floor areas or dimensions on this plan. For more information on the method used for calculating the floor area of any unit, reference should be made to Builder Bulletin No. 22 published by Tarion, E. & O.E. March 2021.

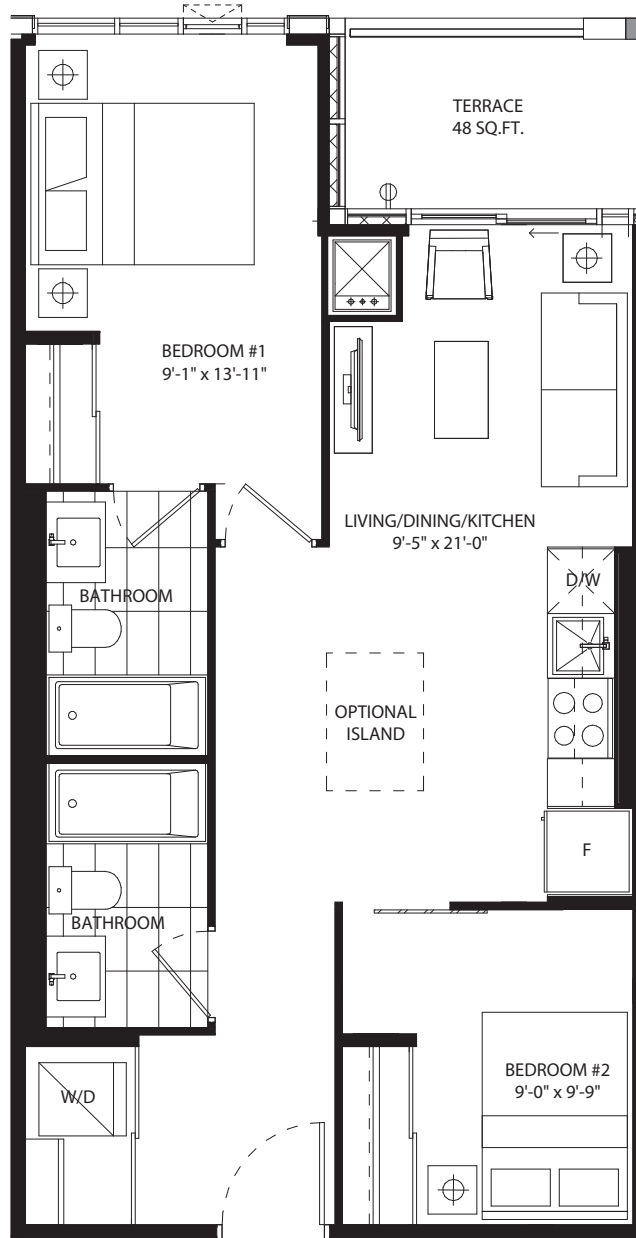



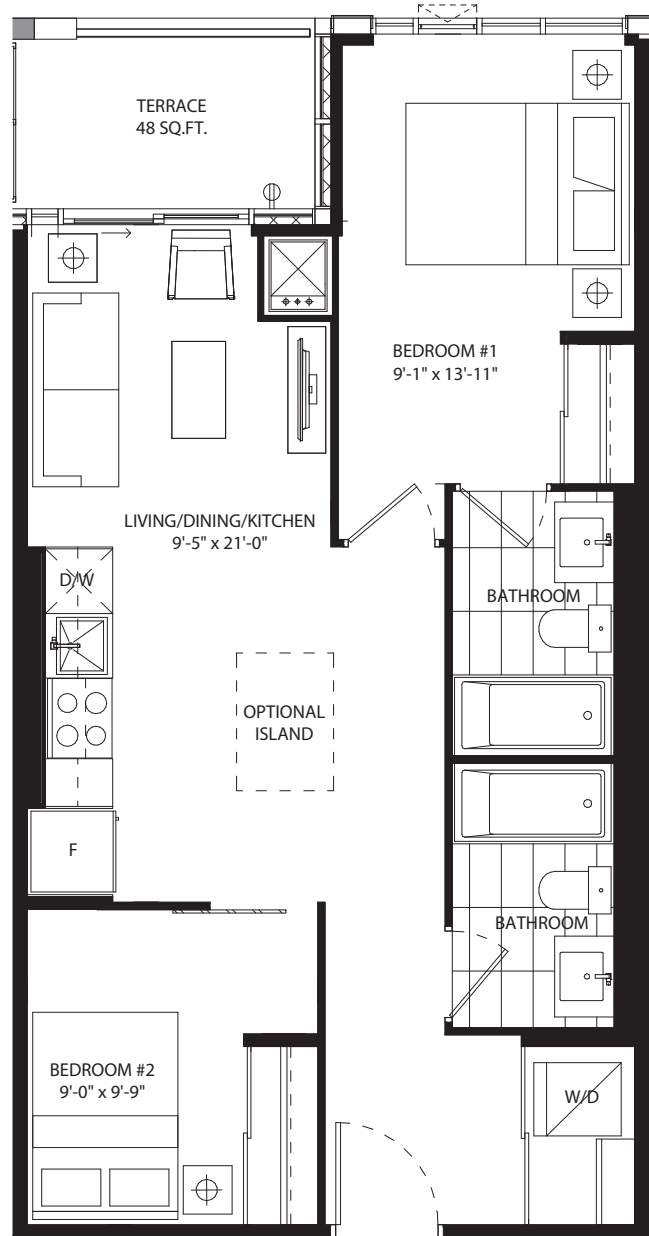

Exterior, windows, colours, grading, landscaping, garage and entrance doors may vary from the renderings. Furniture is displayed for illustration purposes only and does not necessarily reflect the electrical plan for the unit. Units are sold unfurnished. Materials, sizes and specifications are subject to change without notice. Orientation of suite may be reversed and purchaser agrees to accept same. Exterior colours, grading, landscaping, garage and entrance doors may vary from the renderings. All Schedule Ys attached to the legal agreement of purchase and sale supersede artist's renderings. The dimensions shown on this plan are approximate only. Actual useable floor space within the unit may vary from any stated floor areas or dimensions on this plan. For more information on the method used for calculating the floor area of any unit, reference should be made to Builder Bulletin No. 22 published by Tarion, E. & O.E. March 2021.



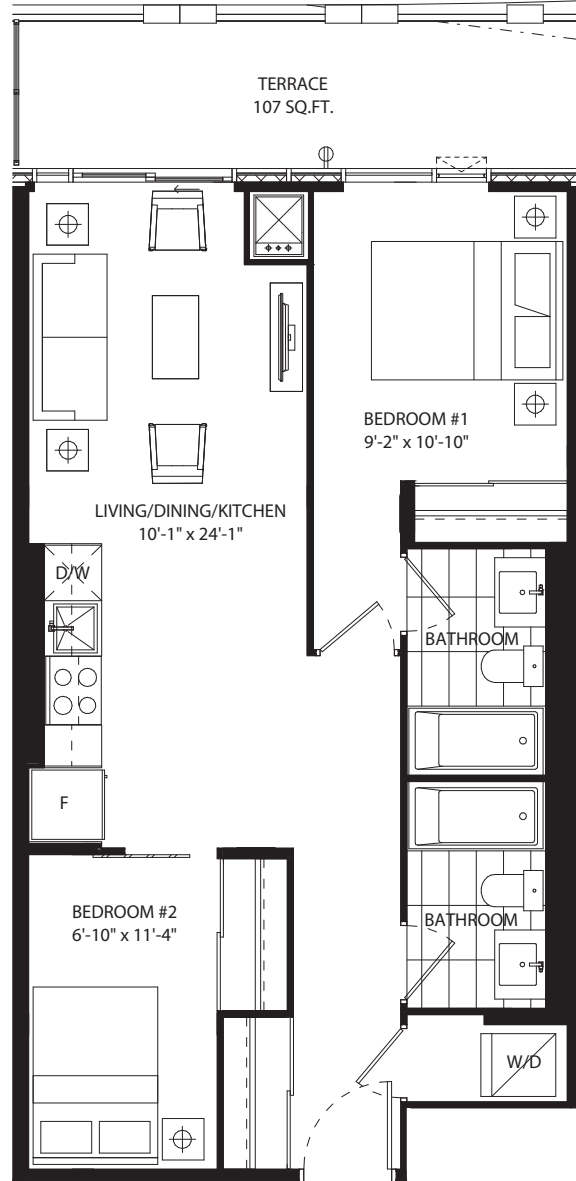

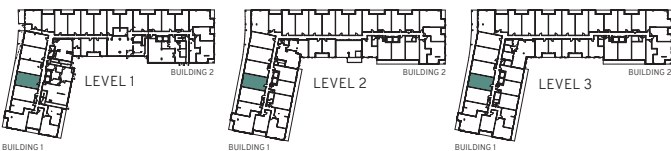
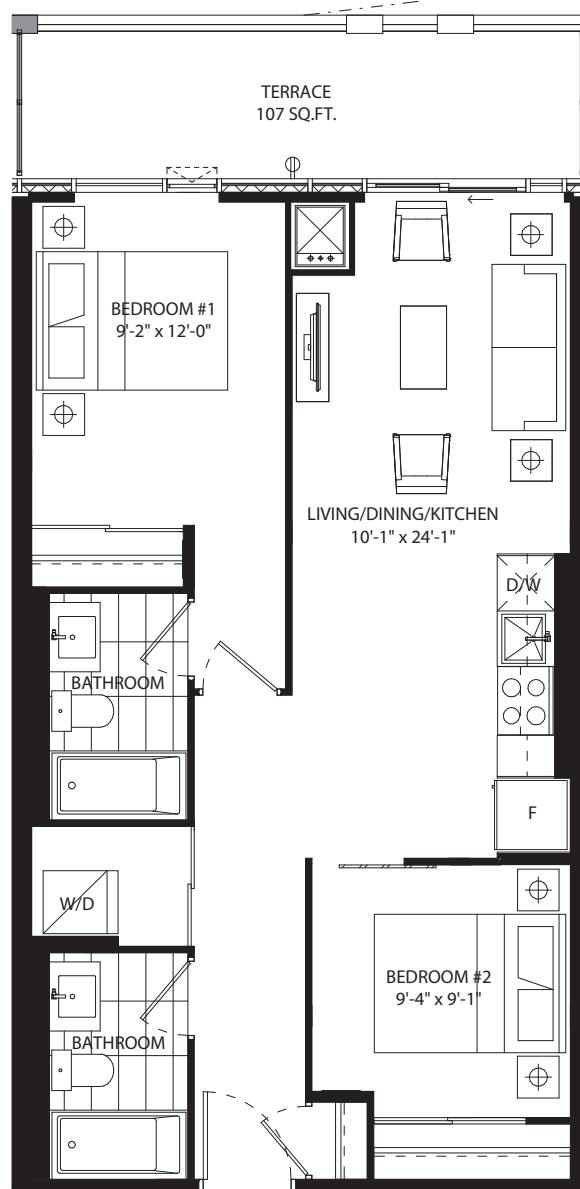

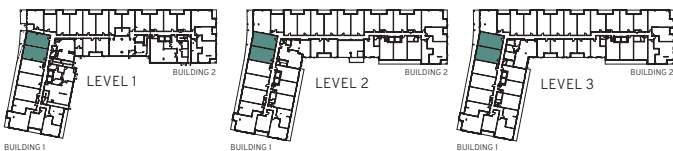
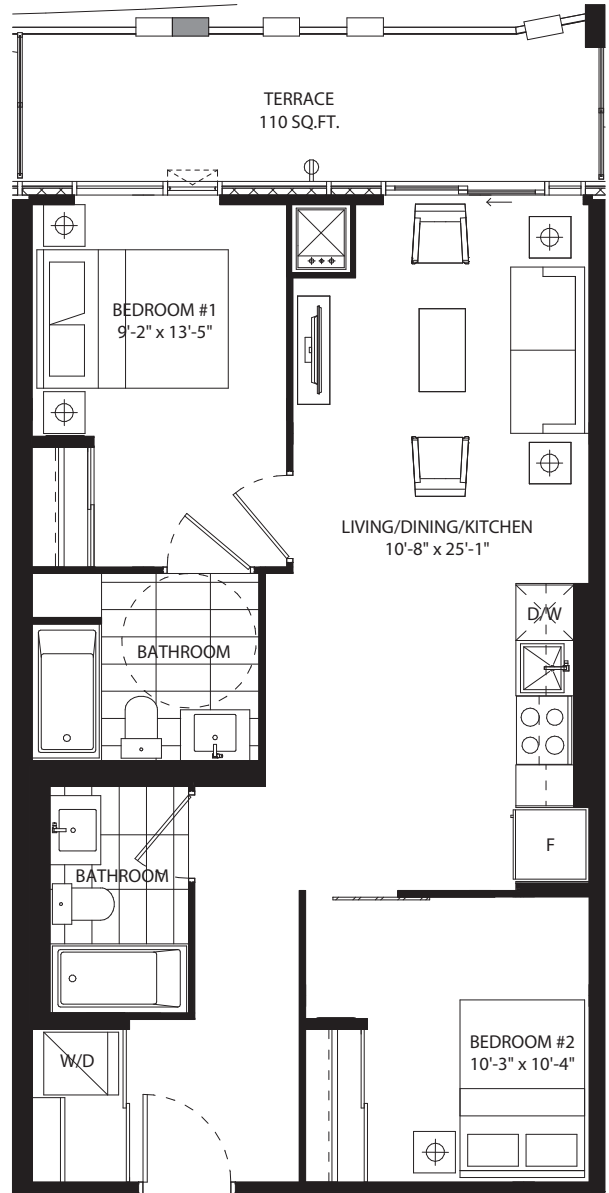
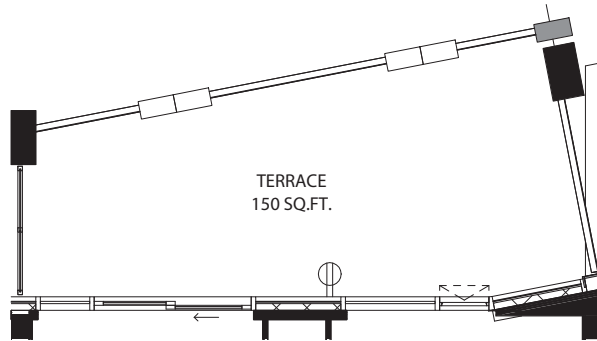

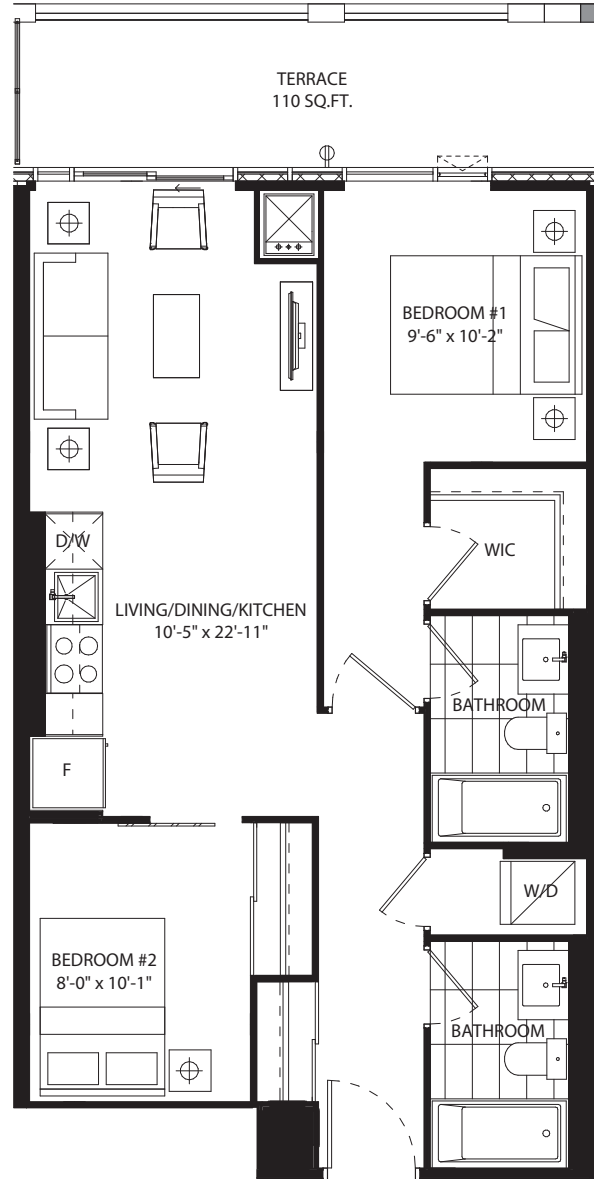



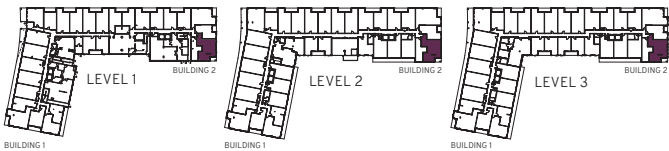
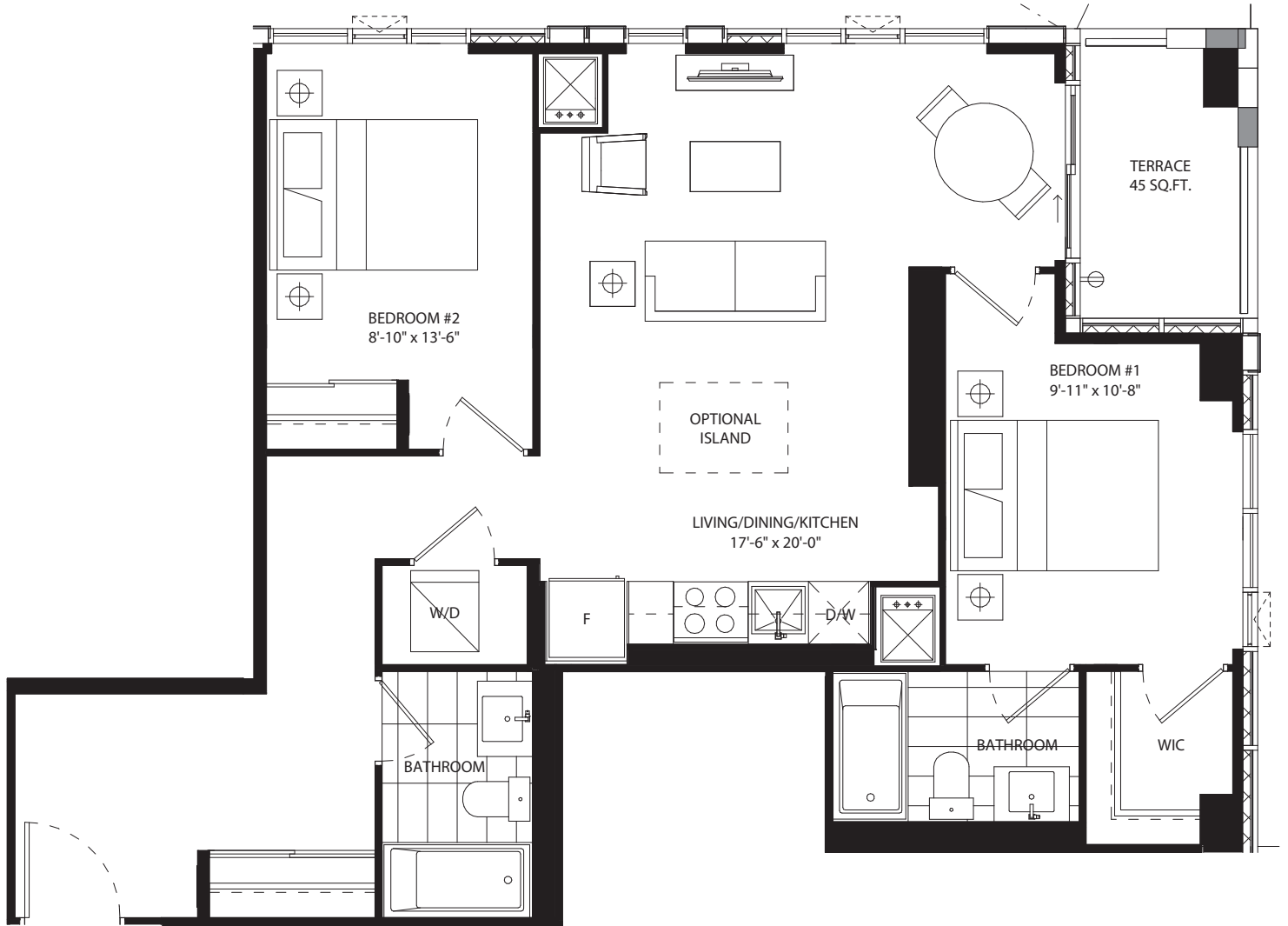

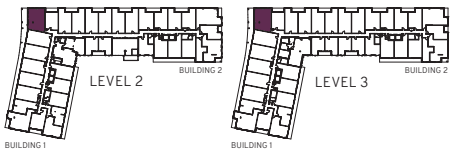

Exterior, windows, colours, grading, landscaping, garage and entrance doors may vary from the renderings. Furniture is displayed for illustration purposes only and does not necessarily reflect the electrical plan for the unit. Units are sold unfurnished. Materials, sizes and specifications are subject to change without notice. Orientation of suite may be reversed and purchaser agrees to accept same. Exterior colours, grading, landscaping, garage and entrance doors may vary from the renderings. All Schedule Ys attached to the legal agreement of purchase and sale supersede artist's renderings. The dimensions shown on this plan are approximate only. Actual useable floor space within the unit may vary from any stated floor areas or dimensions on this plan. For more information on the method used for calculating the floor area of any unit, reference should be made to Builder Bulletin No. 22 published by Tarion, E. & O.E. March 2021.





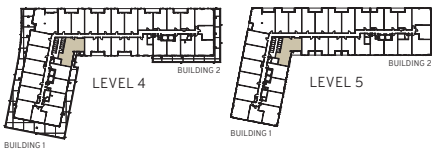

Exterior, windows, colours, grading, landscaping, garage and entrance doors may vary from the renderings. Furniture is displayed for illustration purposes only and does not necessarily reflect the electrical plan for the unit. Units are sold unfurnished. Materials, sizes and specifications are subject to change without notice. Orientation of suite may be reversed and purchaser agrees to accept same. Exterior colours, grading, landscaping, garage and entrance doors may vary from the renderings. All Schedule Ys attached to the legal agreement of purchase and sale supersede artist's renderings. The dimensions shown on this plan are approximate only. Actual useable floor space within the unit may vary from any stated floor areas or dimensions on this plan. For more information on the method used for calculating the floor area of any unit, reference should be made to Builder Bulletin No. 22 published by Tarion, E. & O.E. March 2021.



